

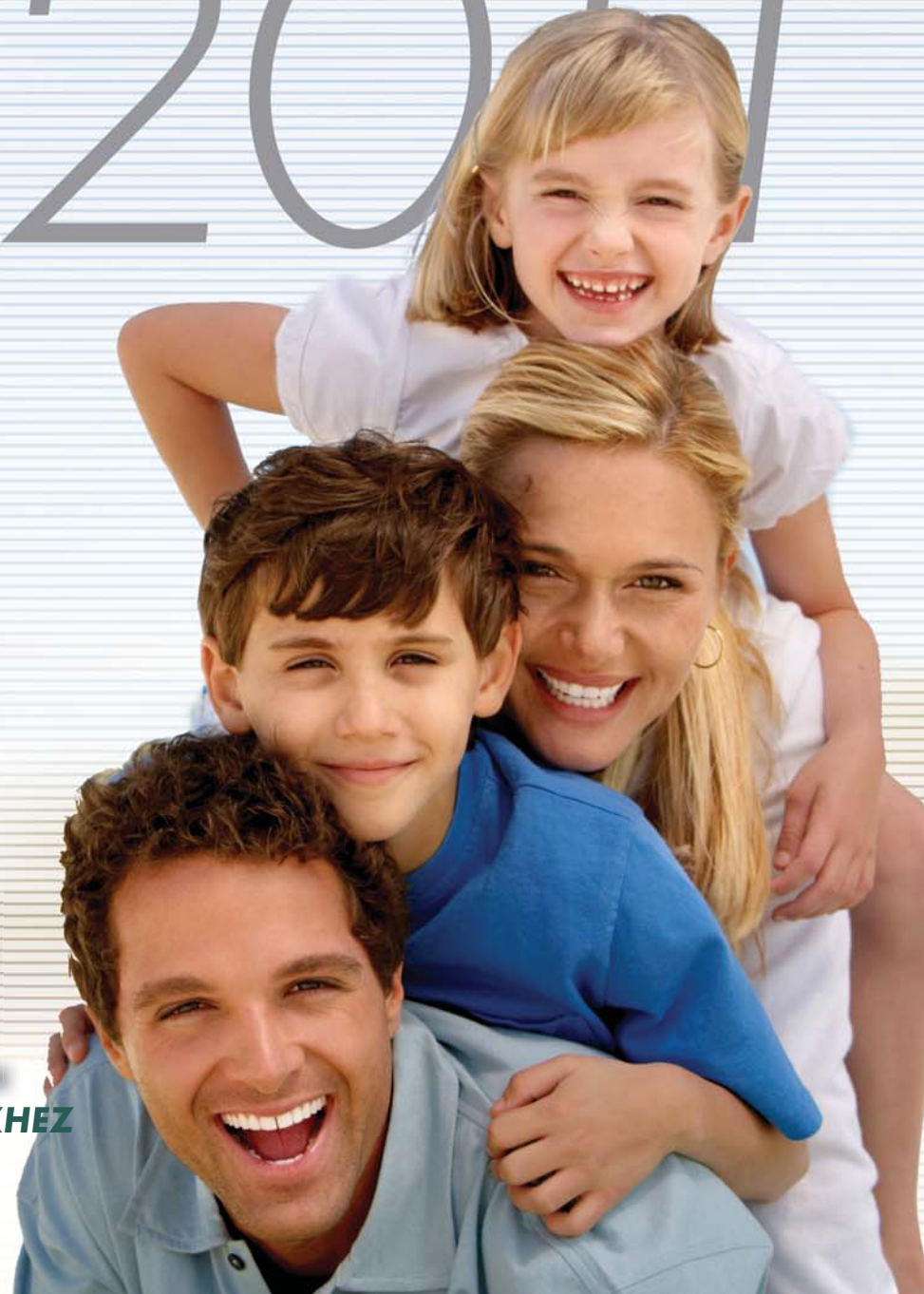

2011



GAVA *plast*

AJTÓBETÉTEK MŰANYAG ÉS ALUMÍNIUM PROFILRENDSZEREKHEZ





GAVA plast

GAVA aluminium

GAVA hpl

kiegészítők

technikai adatok

3

43

71

93

97





GAVA 271
aranytölgy

GAVA *plast*

AJTÓBETÉTEK MŰANYAG ÉS ALUMÍNIUM PROFILRENDSZEREKHEZ

2-3

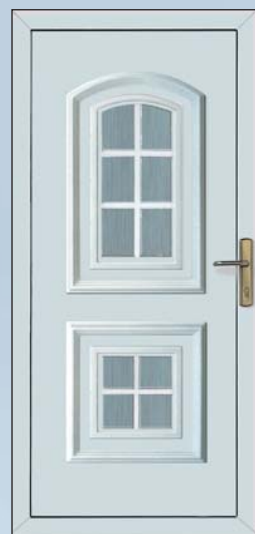

GAVA **010**,
16 mm-es fehér
áloztóval



GAVA **012**



GAVA **014**,
8 mm-es fehér
áloztóval



GAVA **015**



GAVA **011**

Tiffany üvegek



GAVA 012
,Arkada'



GAVA 012
,Klasik'



GAVA 012
,Raute'



GAVA 012
,Kala'



GAVA 012
,Twist'



GAVA 012 + 012/2
,Abstrakt'



GAVA 011
aranytölgy



GAVA 014-V
Planibel bronz
domborított üveggel
8mm-es arany színű
álosztóval



GAVA 015-V
Stopsol bronz
domborított üveggel

DecorGlass üvegek



GAVA **012** ,Leaves'



GAVA **012**
,Light Ray'



GAVA **012**
,Karo'



GAVA **012**
,Rosa'



DecorGlass üvegek



GAVA 012
,Royal'



GAVA 012
,Tulip'



GAVA 012
,Fazeta'



GAVA 012
,Twist 2'



GAVA 012
,Moher'

FussingGlass



GAVA 012
,Hviezdny prach'

Tiffany üvegek



GAVA 012
,Kolibrík'



GAVA 012
,Motýle'



GAVA 012
,Volavka'



GAVA 012
,Vlčie maky'



GAVA 021
,Avalon'



GAVA 020



GAVA 021



GAVA 022
8mm-es fehér
álosztóval



GAVA 023
aranytölgy,
8mm-es bronz színű
álosztóval



GAVA 024
8mm-es arany színű
álosztóval

Tiffany üveg



GAVA 021
,Volavka'



GAVA 021
,Kala'



GAVA 021
,Listy'



GAVA 021
,Karo'



GAVA 021
,Light Ray'

DecorGlass üveg



GAVA 021
mahagón,
'Jeseň'

GAVA 021/2
mahagón,
'Jeseň'



FussingGlass



GAVA 021
,Hviezdy prach'



GAVA 021
,Jeseň'



GAVA 021
,Vlčie maky'



GAVA 021
,Trojruža'

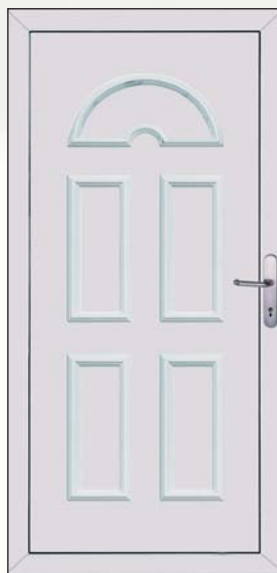

GAVA 030

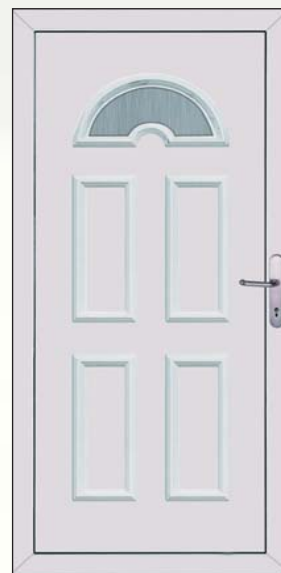

GAVA 031

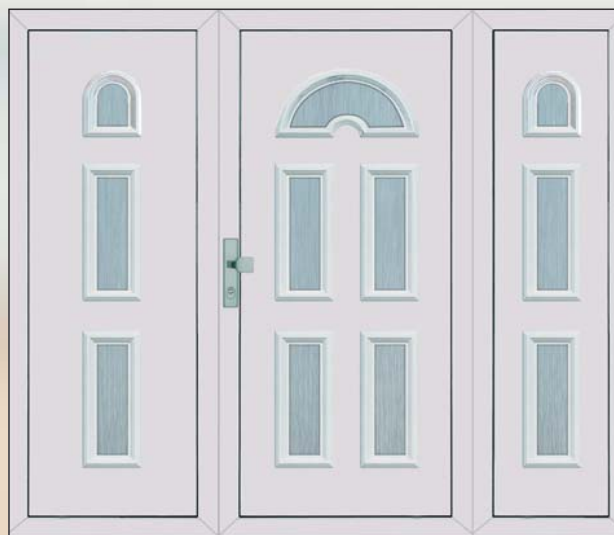

GAVA 033/2 extra, GAVA 033, 033/2

Domborított üveg



GAVA 032-V
aranytölgy, domborított Stopsol bronz üveg

DecorGlass üvegek



GAVA 031
8mm-es fehér
álosztóval

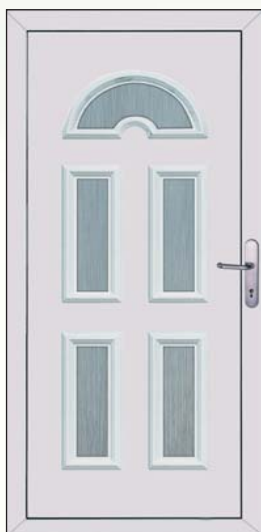

GAVA 033



GAVA 034
16mm-es fehér
álosztóval

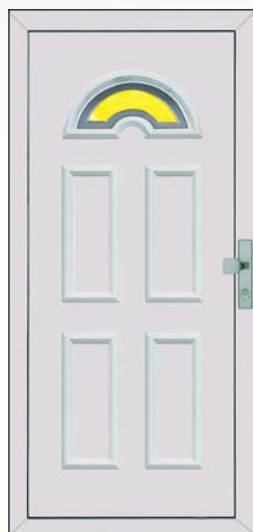

GAVA 031
,Maroko'



GAVA 032
,Maroko'



GAVA 033,
,Maroko'
033/2
,Maroko'



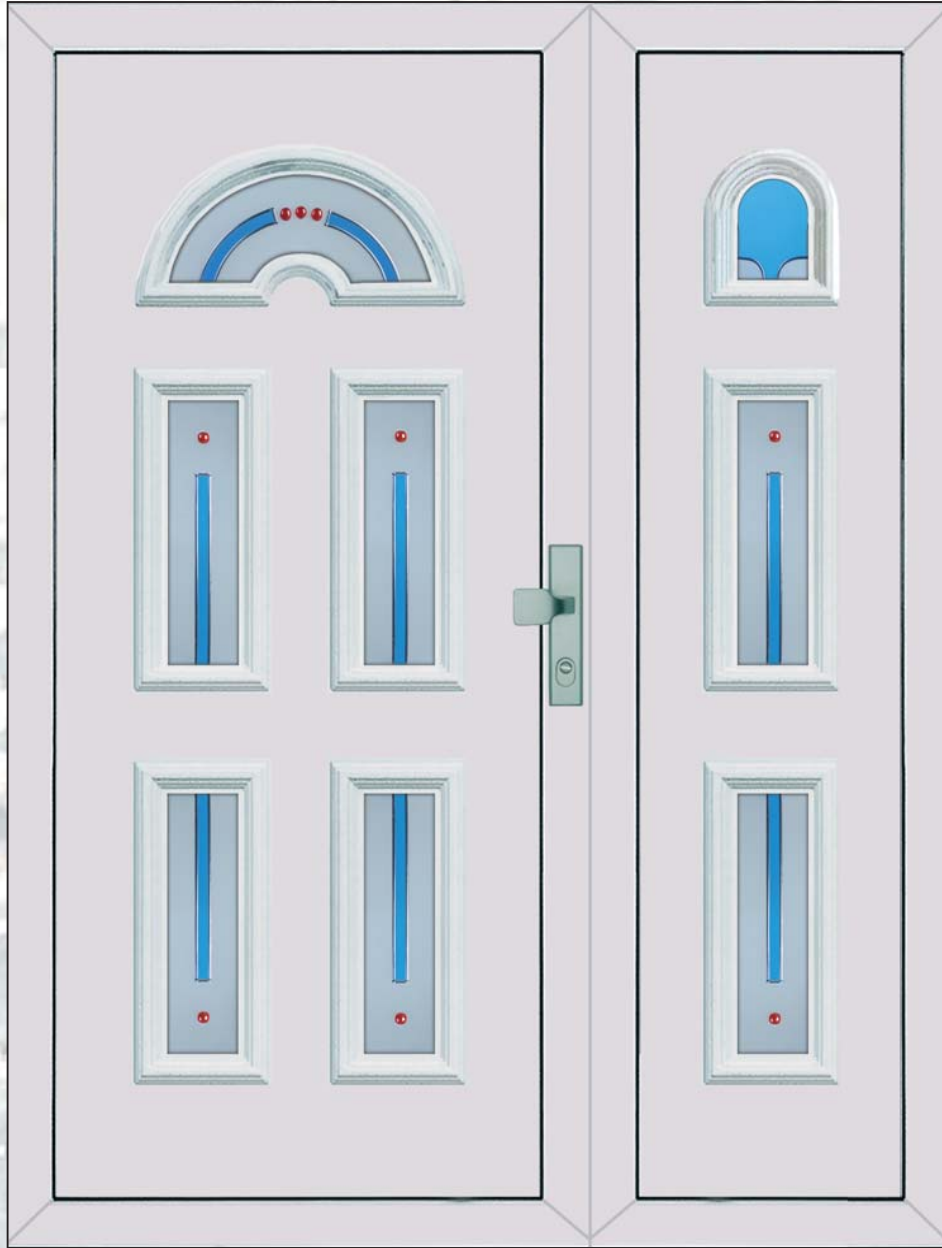

GAVA 033
,Rubín'

GAVA 033/2
'Rubín'



GAVA 032
,Rain'

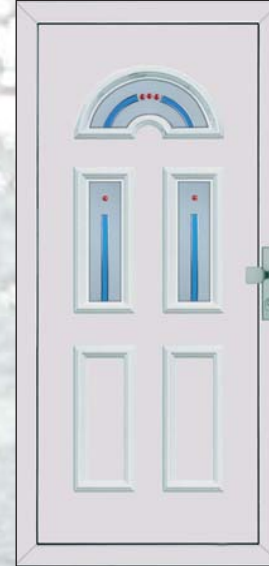

GAVA 032
,Rubín'

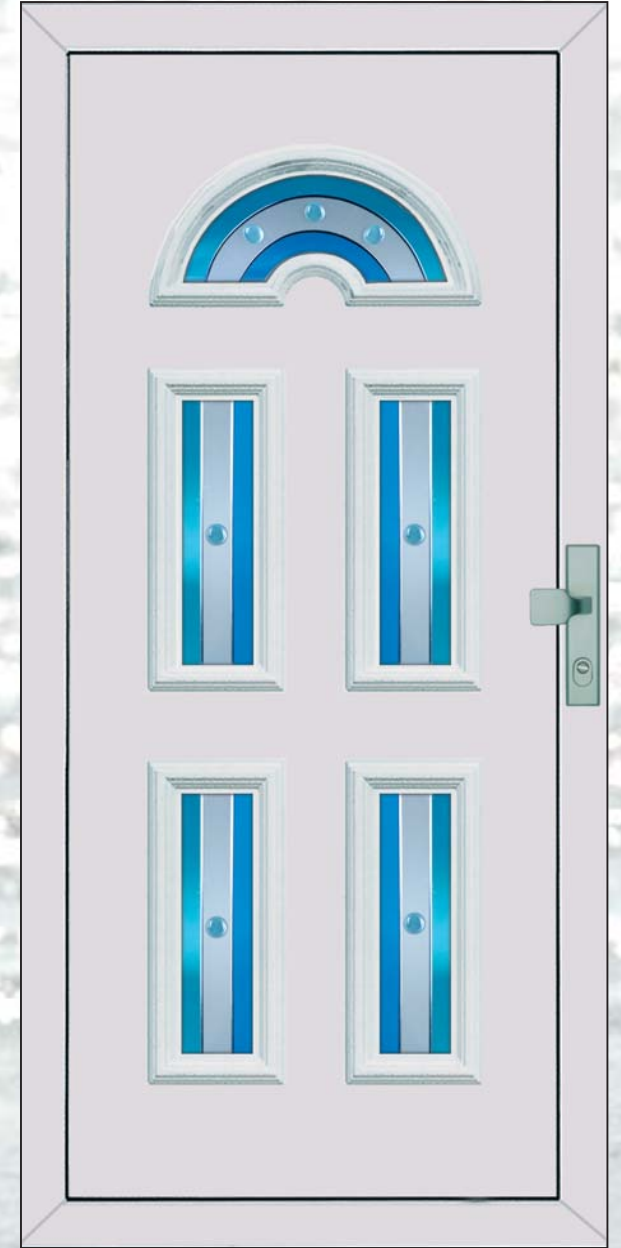

GAVA 033
,Rain'

DecorGlass üvegek



GAVA **031**
,Rose'



GAVA **032**
,Rose'



GAVA **033**
,Rose'

GAVA **033/2**
,Rose'



GAVA **032**
,Iris'



GAVA **032**
,Water-Lily'

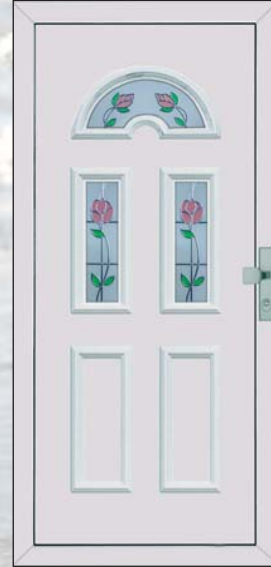

GAVA **032**
,Violet'



GAVA plast CLASSIC

GAVA 030

12-13

DecorGlass üvegek



GAVA **041** aranytölgy,
'Symphony'



GAVA **040**

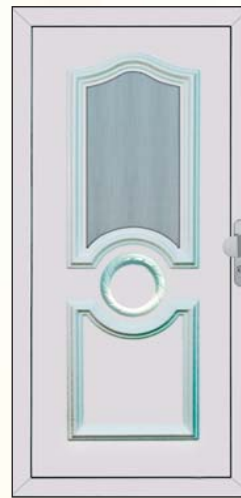

GAVA **041**



GAVA **042,** **042/2**

DecorGlass üvegek

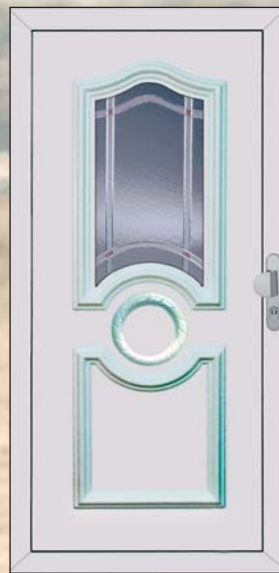

GAVA **041**
'Frame'



GAVA **041**
'Leaves'

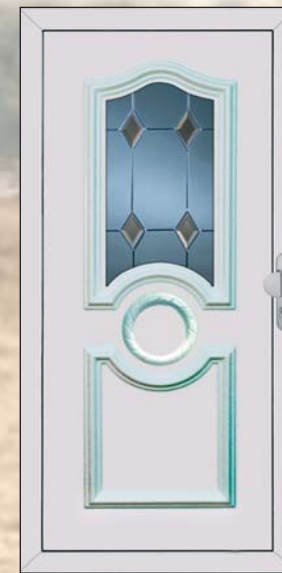

GAVA **041**
'Laura'



DecorGlass üvegek



GAVA **074**
,Rain'

GAVA **074/2**
,Rain'

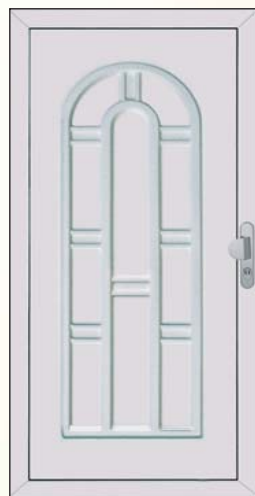

GAVA **070**



GAVA **071**
aranytölgy



GAVA **072** **072/2**



GAVA **073**



GAVA **074** **074/2**

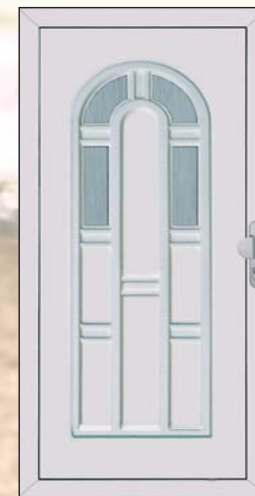

GAVA **075**

DecorGlass üvegek



GAVA **063**
,Polár'

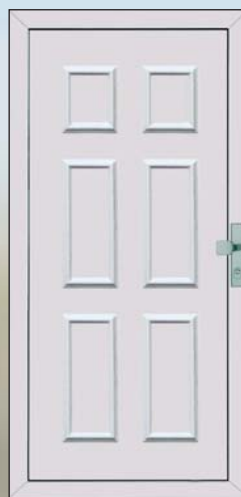

GAVA **060**

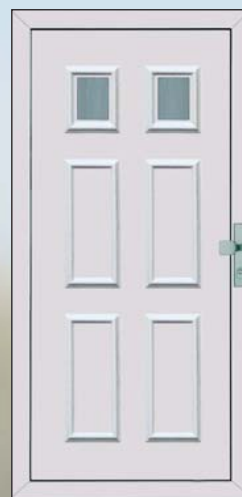

GAVA **061**

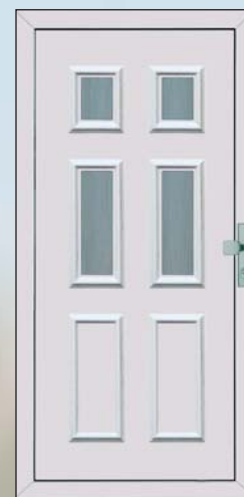

GAVA **062**

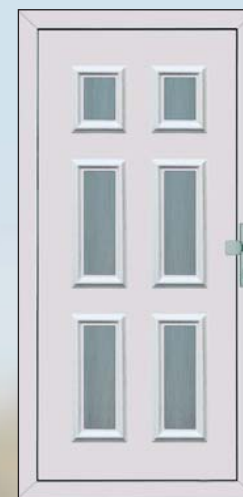

GAVA **063**

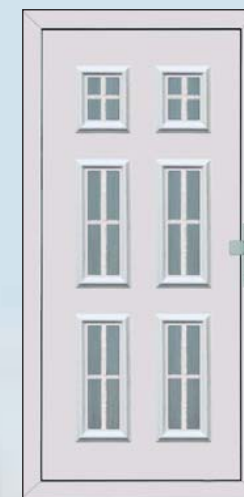

GAVA **064**
16mm-es fehér
álosztóval

DecorGlass üvegek



GAVA **062**
,River'



062/2
,River'

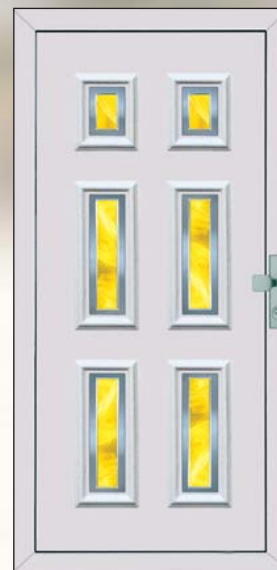

GAVA **063**
,Maroko'

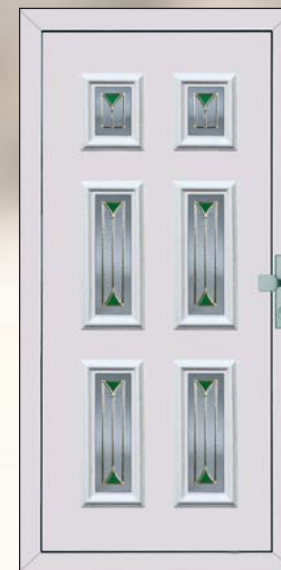

GAVA **063**
,Spike'



GAVA 280



GAVA 281



GAVA 282



GAVA 283



GAVAplast CLASSIC

GAVA 060

GAVA 280

16-17



DecorGlass üvegek

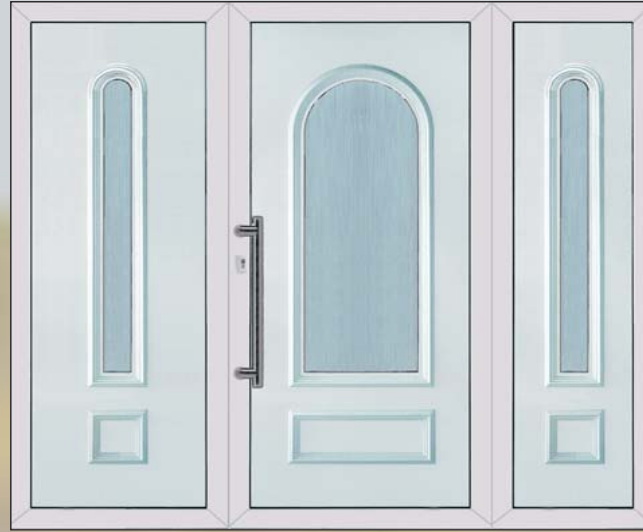

GAVA **241/2 extra**, GAVA **241**, **241/2**

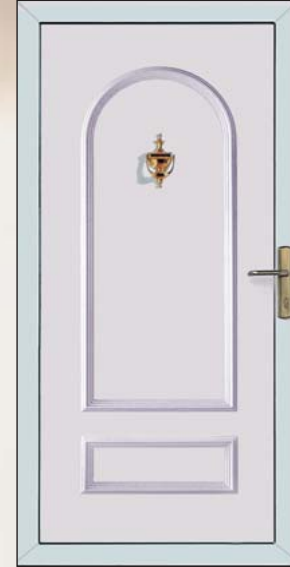

GAVA **240**



GAVA **241**
,Flora'

DecorGlass üvegek



GAVA **081**
,Spiral'



GAVA **081**
,Plane'



GAVA **080**



GAVA **081,** **081/2**



GAVA **082**



GAVA **250**



GAVA **251**

GAVAplast CLASSIC

GAVA 080
GAVA 240
GAVA 250

18-19



GAVA 090



GAVA 091



GAVA 091
aranytölgy

DecorGlass üvegek



GAVA 091
,Wave'



GAVA 091
,Sinus'



GAVA 091
,Jane'



GAVA 260



GAVA 091
,Washington'



GAVA 091
,Sahara'



GAVA 091
,Moon'



GAVA 261

GAVAplast MODERN

GAVA 090
GAVA 260

20-21

DecorGlass üvegek



GAVA **052**
,Forum'



GAVA **050**



GAVA **050**
aranytölgy



GAVA **051**



GAVA **050/2, GAVA 052** **052/2**



DecorGlass üvegek

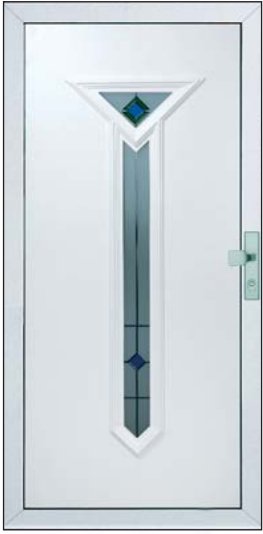

GAVA 232
'Briliant'

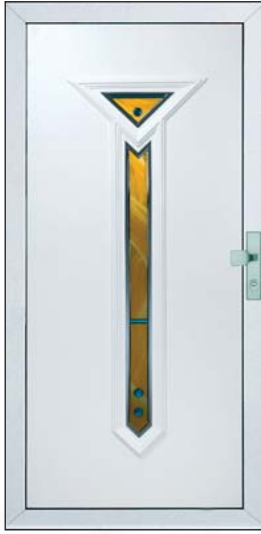

GAVA 232
'Fortuna'

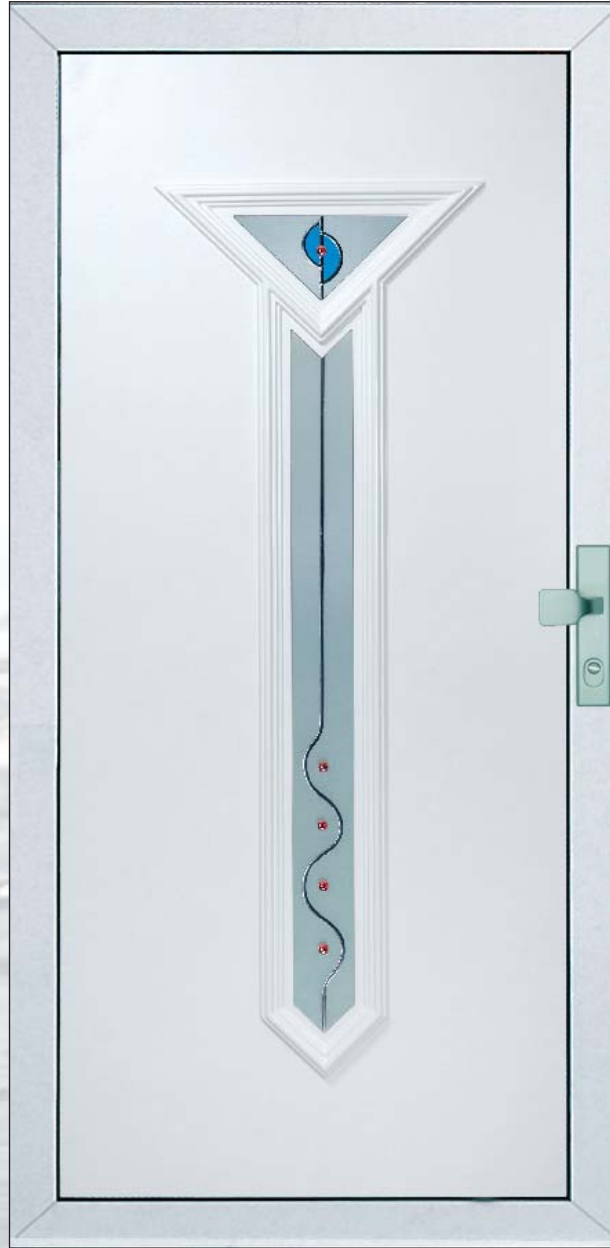

GAVA 232
'Spiral'



GAVA 230



GAVA 231

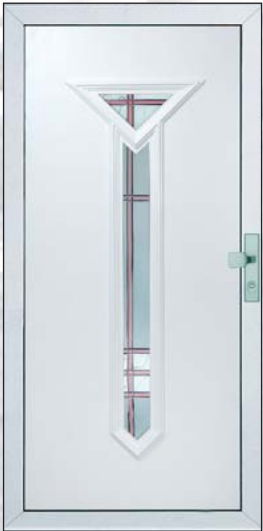

GAVA 232
'Kompas'

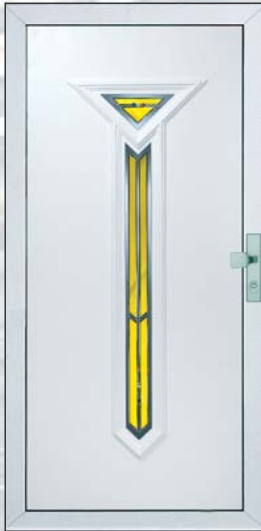

GAVA 232
'Vector'

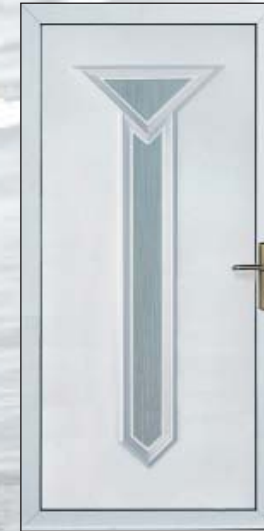

GAVA 232



GAVA 101 P
homokfúvott üveg
,négyzetek 3x12'
Float-planitherm

GAVA 101/2 P
homokfúvott üveg
,négyzetek 12'
Float-planitherm

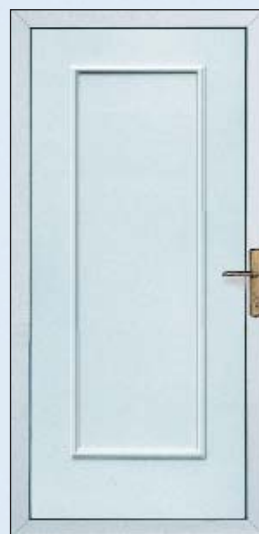

GAVA 100



GAVA 101



GAVA 101 P
homokfúvott üveg
,négyzetek 9'



GAVA 110



GAVA 111



GAVA 112



GAVA 121
,Master-carré' üveggel



GAVA 120



GAVAplast MODERN

GAVA 100
GAVA 120
24-25

DecorGlass üvegek



GAVA 101
,Theby'



GAVA 101
,Progres'



GAVA 101
,Tulip'

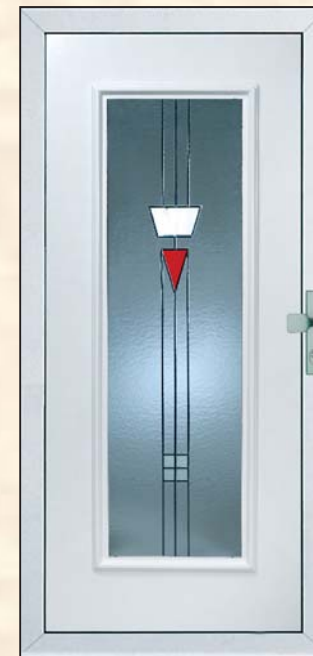

GAVA 101
,Prima'



GAVA 101
,Bird'



GAVA 101/2 extra, 101, 101/2

DecorGlass üvegek

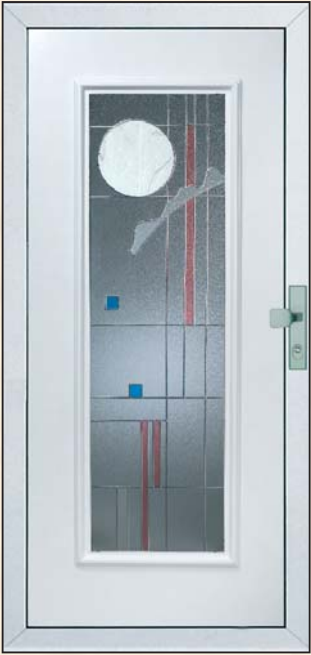

GAVA 101
,Future'

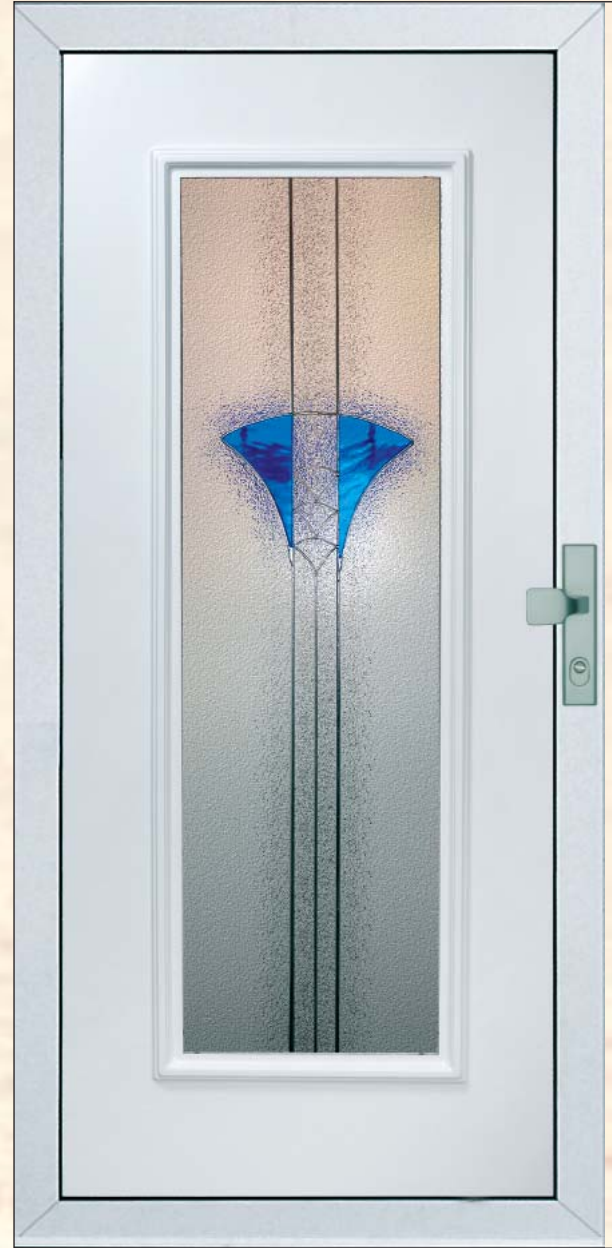

GAVA 101
,Light Ray'

GAVAplast MODERN

GAVA 101

26-27



GAVA 131

GAVA 131/2

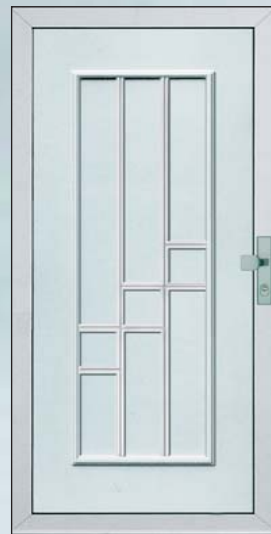

GAVA 130



GAVA 133



GAVA 132, GAVA 132/2



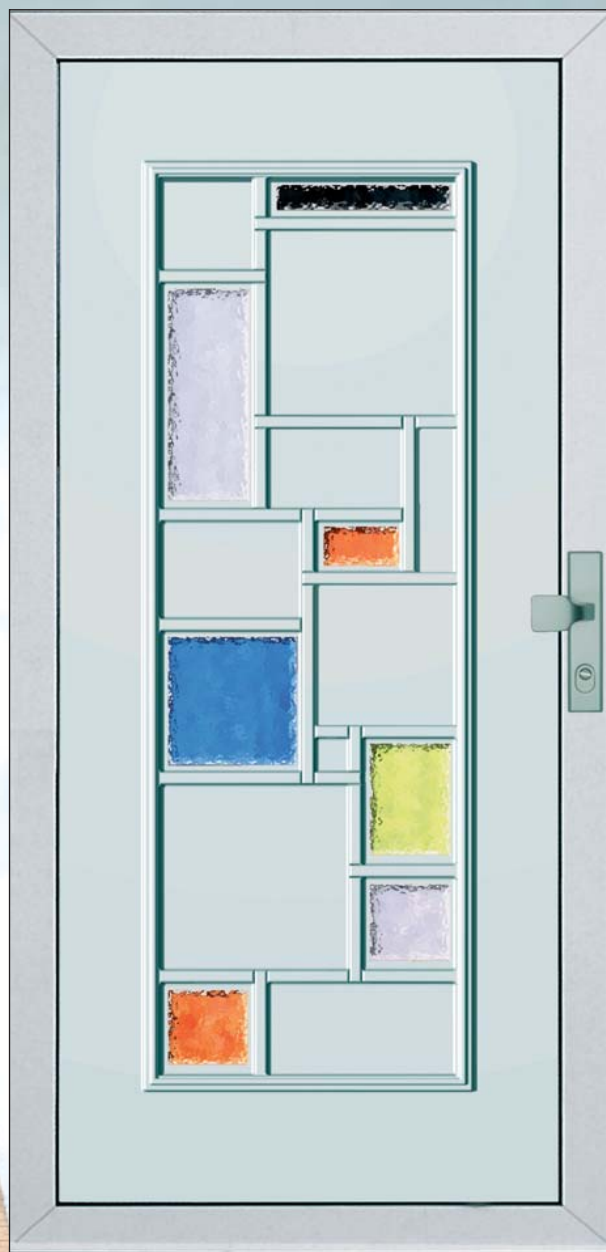

GAVA 142 C
színes üvegek



GAVA 140
antracit

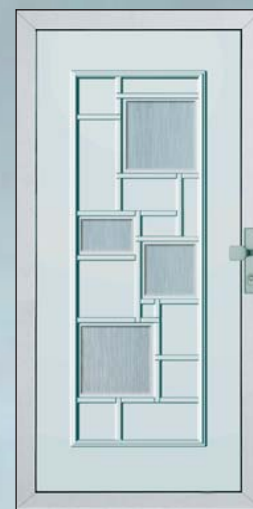

GAVA 141

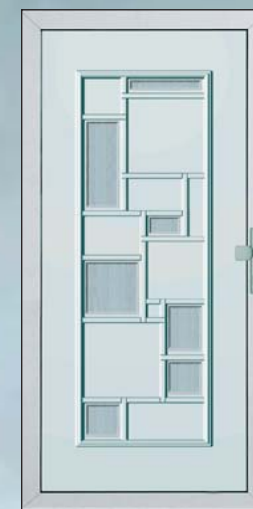

GAVA 142

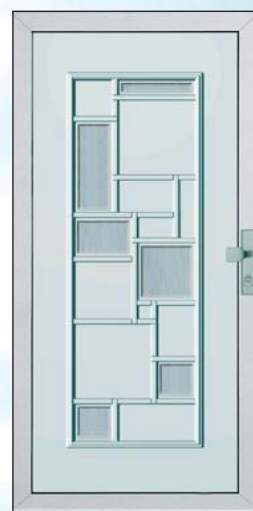

GAVA 143

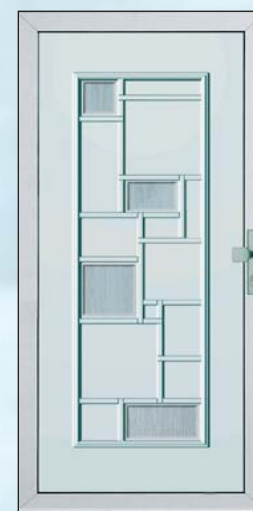

GAVA 144

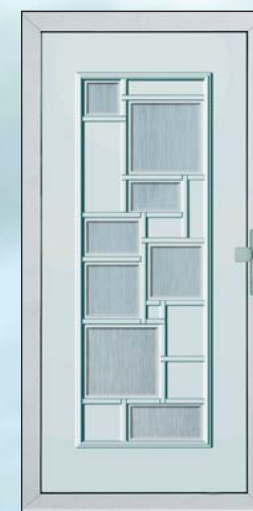

GAVA 145



GAVA 151-P
,négyzetek 12'
Float - planitherm

GAVA 101/2-P
homokfűvott üveg
,négyzetek 12'



GAVA 160



GAVA 161



GAVA 170



GAVA 171



GAVA 181



GAVA 150



GAVA 151



GAVA 152



GAVA 153

DecorGlass üvegek



GAVA 151
,Athene'



GAVA 151
,Drinks'



GAVA 151
,Harmony'



GAVA 151
,Lotos'



GAVA 151
,Array'



DecorGlass üvegek

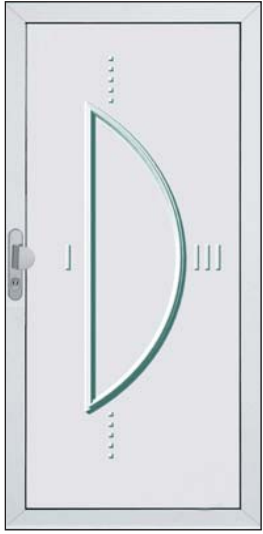

GAVA 210



GAVA 211

GAVA 211



GAVA 211
,Arena'

GAVA 211
,Arena'

DecorGlass üvegek



GAVA 211
,Carnival'

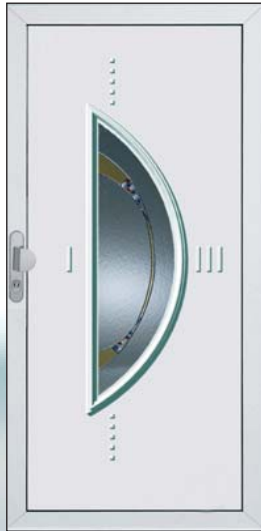

GAVA 211
,Figaro'

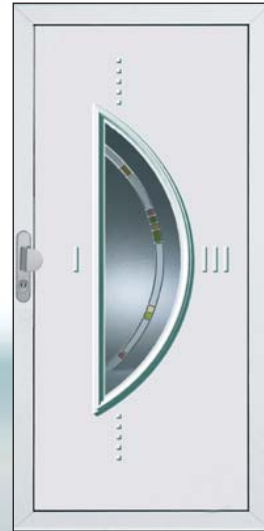

GAVA 211
,Game'

DecorGlass üvegek



GAVA 200



GAVA 201

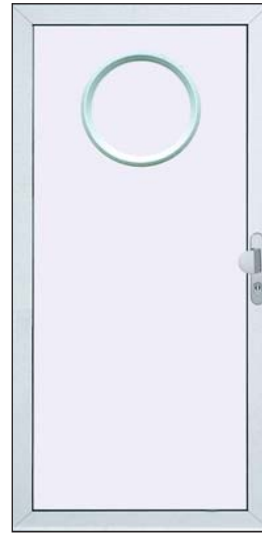

GAVA 205



GAVA 206

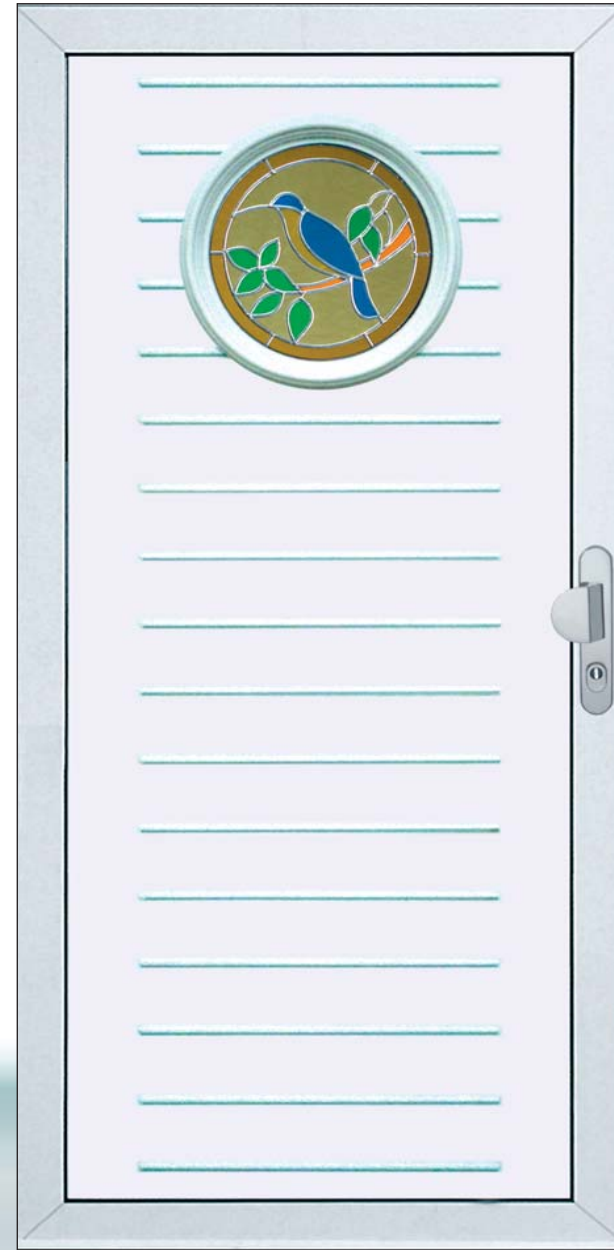

GAVA 201
,Bird'



GAVAplast MODERN

GAVA 200
GAVA 210

32-33

DecorGlass üvegek



GAVA 221
,Senegal'



GAVA 221
,Leaves'



GAVA 221
,Plejades'



GAVA 221
,Laura'



GAVA 221
,Olymp'



GAVA 221
,Tokaj'



GAVA 221
,Freeform'



GAVA 221
,Kankan'



GAVA 225
,Kankan'



GAVA 221
,Flora'



GAVA **220**



GAVA **221**



GAVA **222**
8mm-es
arany színű
álosztóval



GAVA **223**
8mm-es
arany színű
álosztóval



GAVA **225/2**, GAVA **225**



DecorGlass üvegek



GAVA 272
,Metric'



GAVA 272
,Harmony'



GAVA 272
,Plane'



GAVA 272



GAVA 270



GAVA 272
,Flower'



GAVA 272
,Signal'



GAVA 272
,Tennis'



GAVA 271
aranytölgy



GAVA 273



GAVAplast MODERN

GAVA 270

36-37

DecorGlass üvegek



GAVA 290



GAVA 291



GAVA 292
aranytölgy



GAVA 292
sapeli



GAVA 292
'Linea'



DecorGlass üvegek

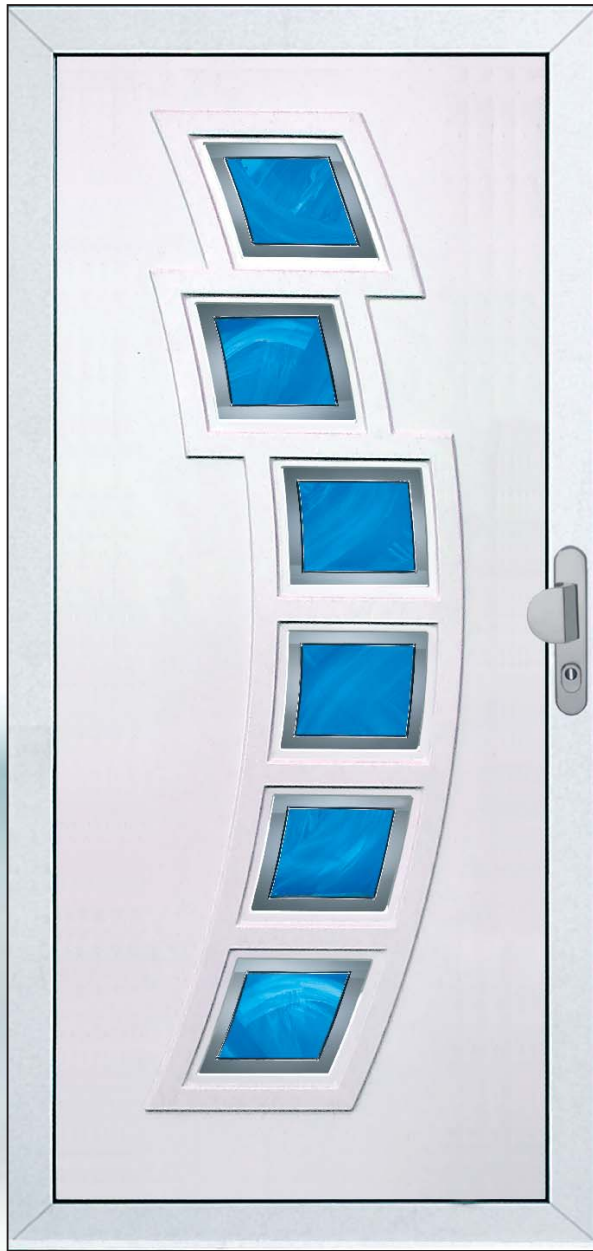

GAVA 292
,Plane'



GAVA 291
,Plane'



GAVA 291
,Linea'



GAVA 291
,Tramín'



GAVA 291
,Color'



GAVA 293
,Color



GAVA 032



GAVA 292 sapeli

PVC panelek színválasztéka



Mooreiche
Renolit 3167 004



Eiche dunkel
Renolit 2052 089



Sapeli
Renolit 2065 021



Mahagon
Renolit 2097 013



Rosewood
Renolit 3202 001



Nussbaum
Renolit 2178 007



Eiche rustikal
Renolit 3149 008



Macore
Renolit 3162 002



Aranytölgy
Renolit 2178 001



Streifendouglas
Renolit 3152 009

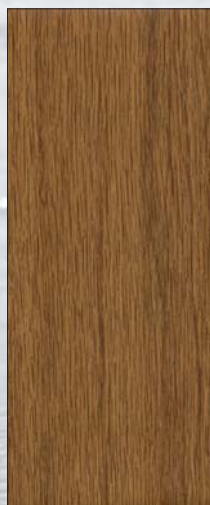

Eiche hell
Renolit 2052 090



**Noce Sorrento
balsamico**
Hornschuch
F439-3042



Cherry amaretto
Hornschuch
F 425-2043

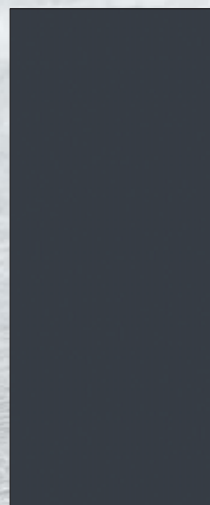

Anthrazitgrau
Renolit 7016 05

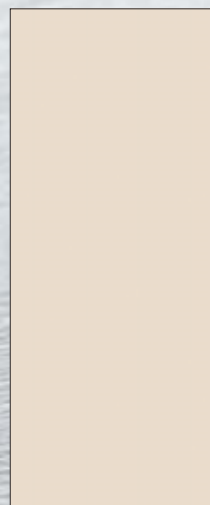

Cremeweiss
Renolit 1379 05

GAVA plast

Technikai adatok PVC panelekhez

Fehér PVC színválaszték:

- C156 – standard fehér
- C145 – salamander fehér
- C152 – Thysen, Veka
- C160 – Gealan, Internova;
- C164 – Rehau

Merevítések:

- XPS
- XPS + acéllemez
- Izofix
- Izofix + acéllemez

Maximális méretek:

- Főpanel maximális mérete: 850mm – 2000mm ± 2mm
- Oldalpanel maximális mérete: 430mm – 2000mm ± 2mm
- Extra oldalpanel maximális mérete: 850mm – 2000mm ± 2mm
(030/2, 100/2, 220/2, 240/2)

Faerezet kivételű panelekbe az IZOFIX merevítés kötelező!

Ajtópanelek vastagságai:

- standard panelek vastagságai: 24mm, 34mm, 36mm, 44mm
- egyedi vastagságok: 30mm, 32mm, 40mm, stb. egyeztetés alapján gyárthatók

Hőátbocsátási tényezők:

- | | |
|---|--|
| • 24 mm: XPS Styrodur 24 $u= 1,04 \text{ W.m}^{-2}.\text{K}^{-1}$ | Izofix 24 $u= 1,73 \text{ W.m}^{-2}.\text{K}^{-1}$ |
| • 34 mm: XPS Styrodur 34 $u= 0,91 \text{ W.m}^{-2}.\text{K}^{-1}$ | Izofix 34 $u= 0,97 \text{ W.m}^{-2}.\text{K}^{-1}$ |
| • 36 mm: XPS Styrodur 36 $u= 0,87 \text{ W.m}^{-2}.\text{K}^{-1}$ | Izofix 36 $u= 1,07 \text{ W.m}^{-2}.\text{K}^{-1}$ |
| • 44 mm: XPS Styrodur 44 $u= 0,72 \text{ W.m}^{-2}.\text{K}^{-1}$ | Izofix 44 $u= 0,86 \text{ W.m}^{-2}.\text{K}^{-1}$ |

XPS Styrodur 24 + acéllemez $u= 1,34 \text{ W.m}^{-2}.\text{K}^{-1}$

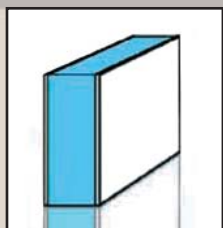

XPS

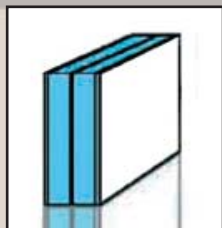

XPS+acéllemez

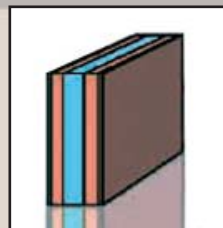

IZOFIX

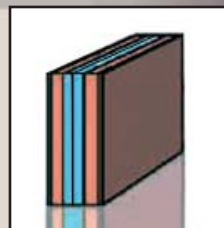

IZOFIX+acéllemez

GAVA 091



The background features a dark red, textured surface with intricate, glowing golden lines that form abstract, organic shapes, possibly resembling stylized leaves or veins. The lines are bright and have a slight glow, contrasting sharply with the dark background.

GAVA *aluminium*

AJTÓBETÉTEK MŰANYAG ÉS ALUMÍNIUM PROFILRENDSZEREKHEZ

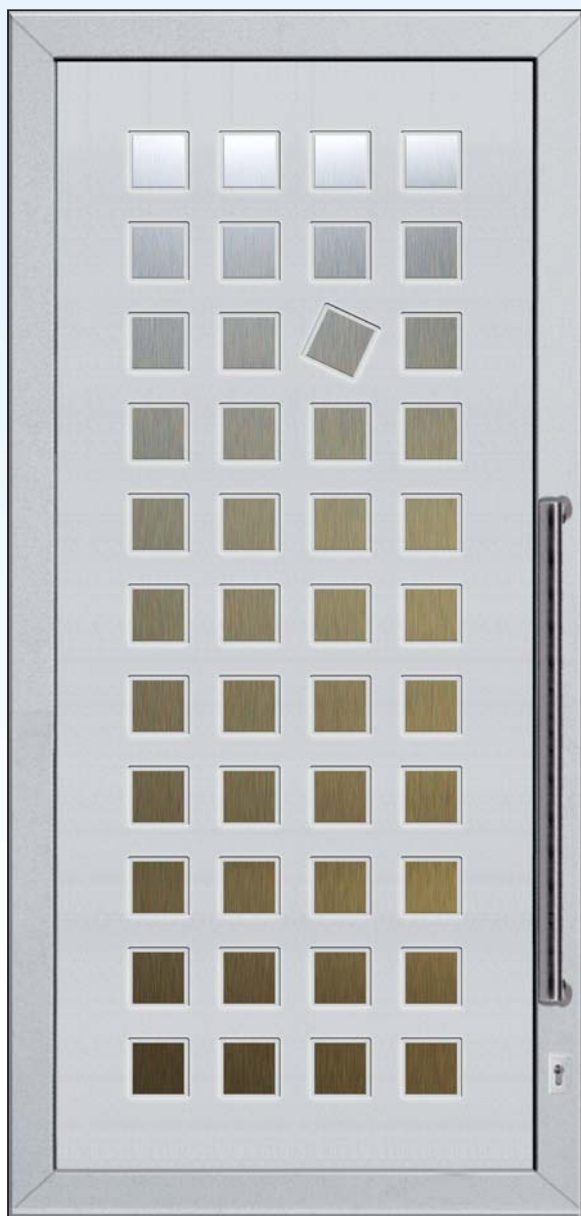

GAVA 407a
rozsdamentes acél négyzetek



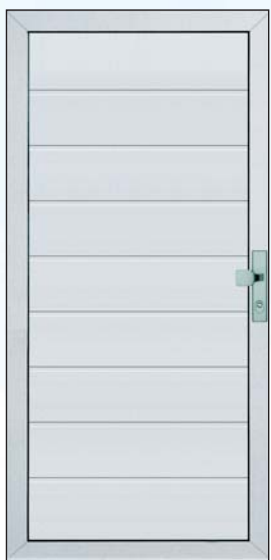

GAVA **400**

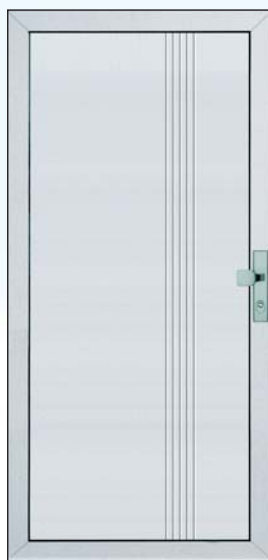

GAVA **401**



GAVA **402**
RAL 1005

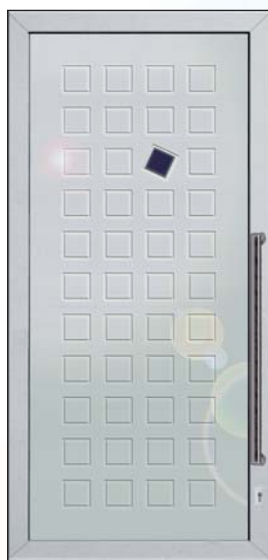

GAVA **407b**
RAL 5003



GAVA **407c**
RAL 3020
RAL 9016



GAVA **405**
RAL 1020



GAVA 403
RAL 6003

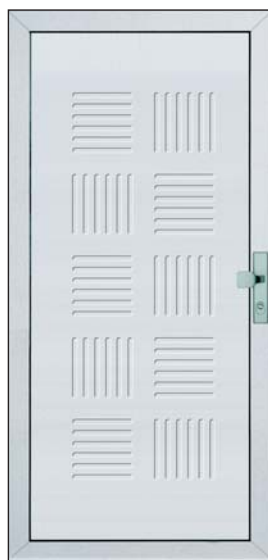

GAVA 404

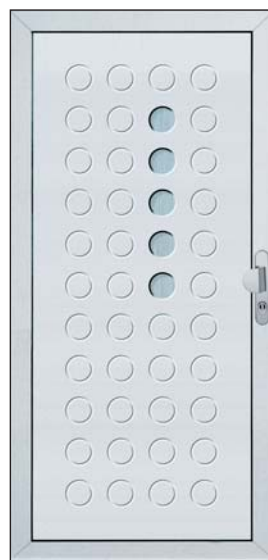

GAVA 406

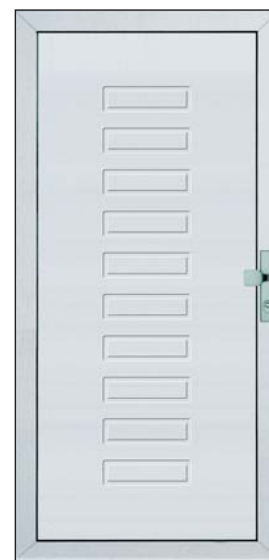

GAVA 408



GAVA 409



GAVA 416a
RAL 9006



GAVA 416a
RAL 5003



GAVA 416b
RAL 8024



GAVA **416b**

GAVA **416c**

RAL 8024

rozsdamentes acél kombináció



AREA
GAVA
aluminium

GAVA 400

GAVA 410

46-47

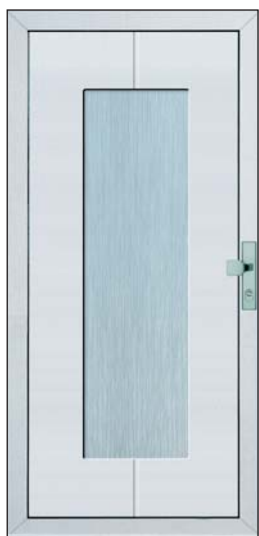

GAVA **410**

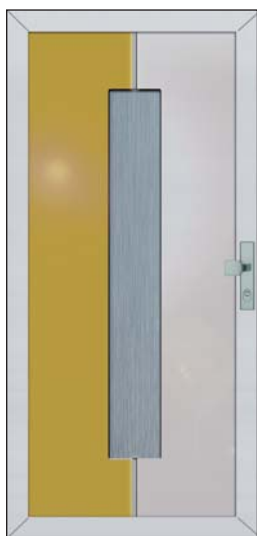

GAVA **411**
RAL 1005

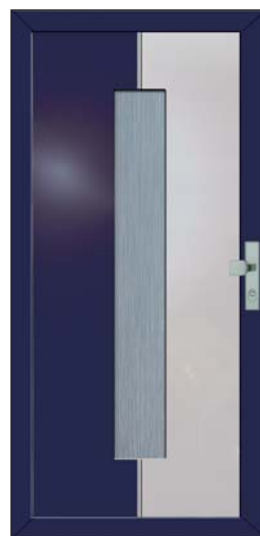

GAVA **411**
RAL 5003

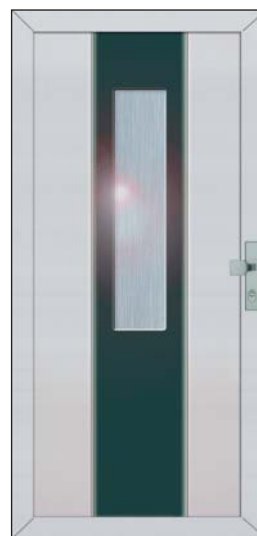

GAVA **415 b**
RAL 6026



GAVA **417**



GAVA **418**

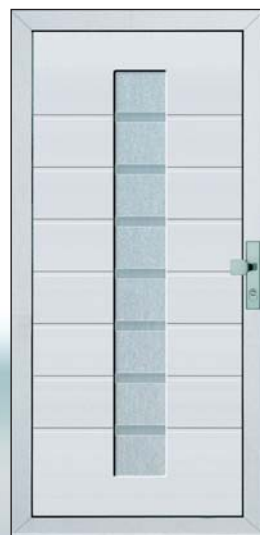

GAVA **419 a**
homokfúvott üveg

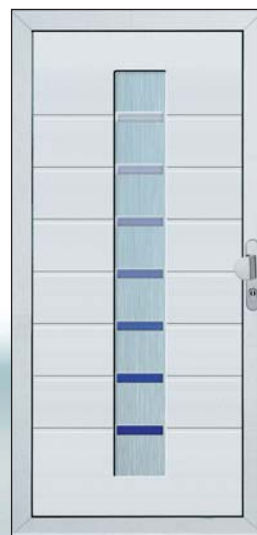

GAVA **419 b**



GAVA **417**
RAL 5003



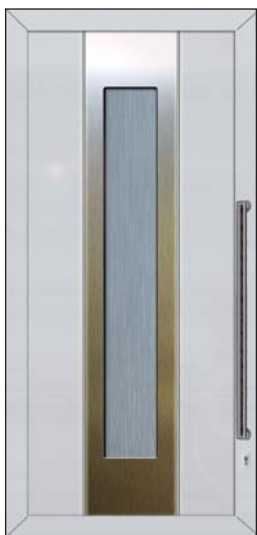

GAVA 412
rozsdamentes
acél kombináció

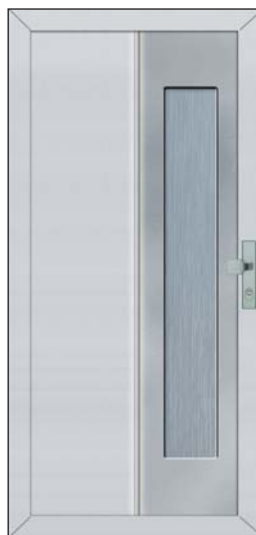

GAVA 414
RAL 9006

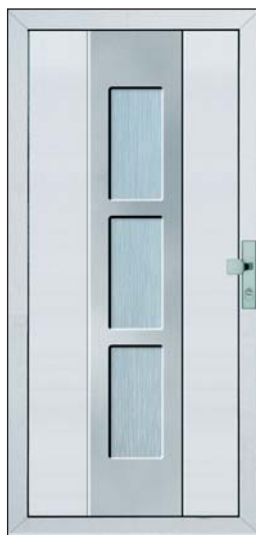

GAVA 413
RAL 9006



GAVA 413
RAL 3003



GAVA 413b
rozsdamentes acél kombináció



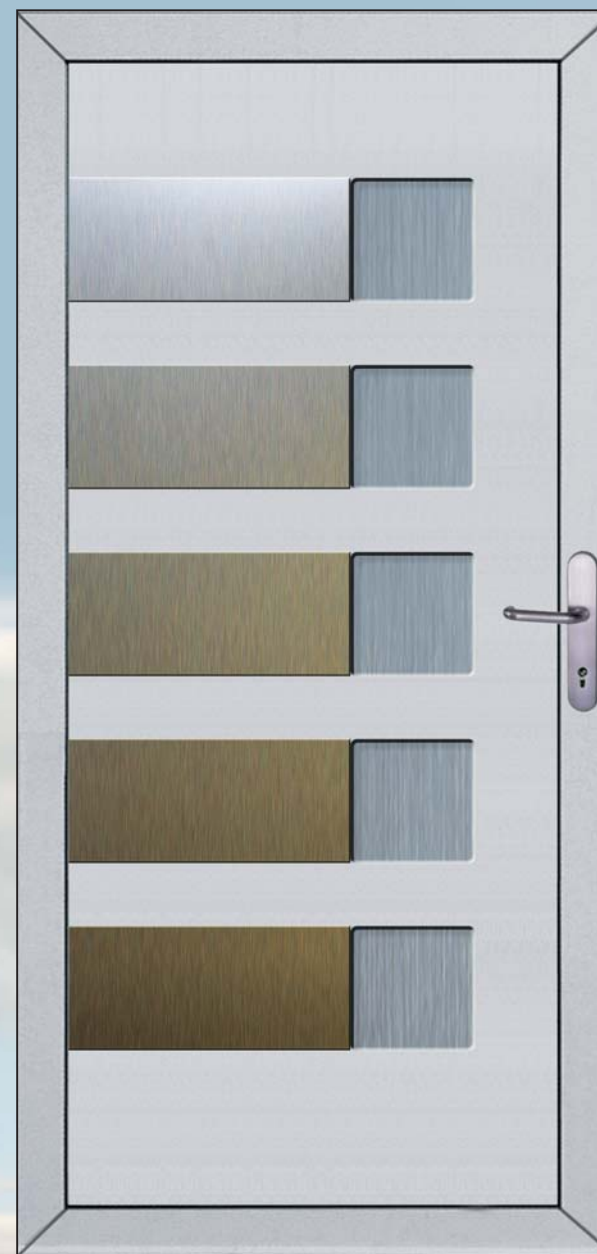

GAVA 429
rozsdamentes acél kombináció



GAVA 428
RAL 8024

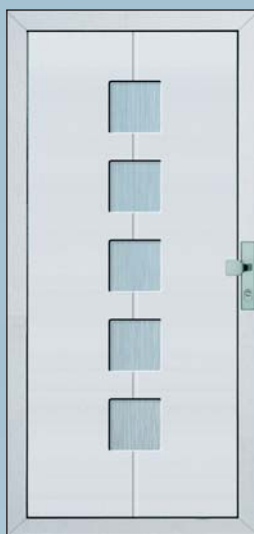

GAVA 426

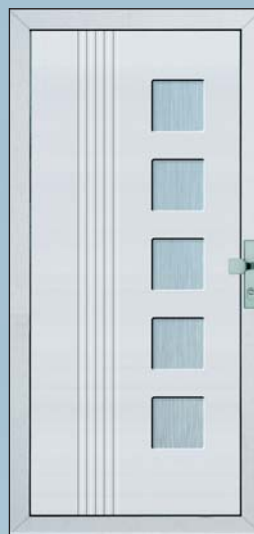

GAVA 427

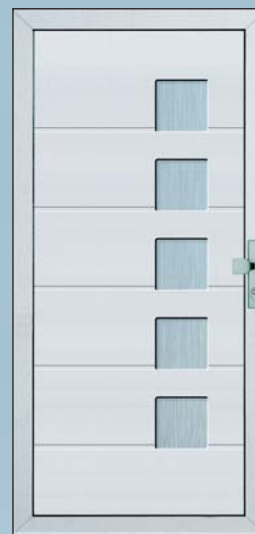

GAVA 428



GAVA 425b
rozsdamentes
acél kombináció



GAVA 429
RAL 5003
rozsdamentes
acél kombináció



GAVA 429
RAL 6026
rozsdamentes
acél kombináció

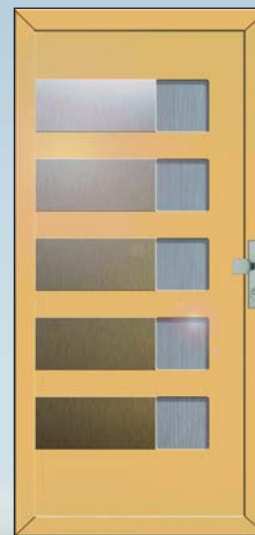

GAVA 429
RAL 1017
rozsdamentes
acél kombináció



GAVA 424

RAL 8024 rozsdamentes acél kombináció

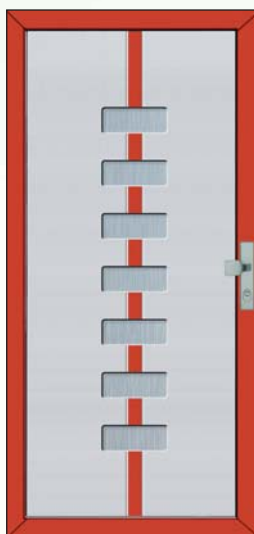

GAVA 420
RAL 3020

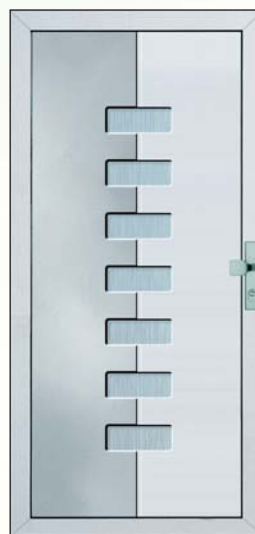

GAVA 421
RAL 9006

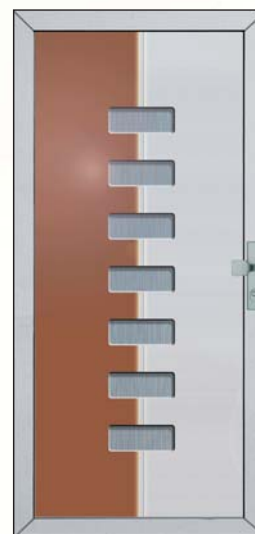

GAVA 421
RAL 8023

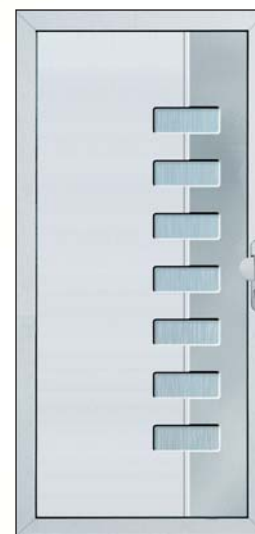

GAVA 422
RAL 9006

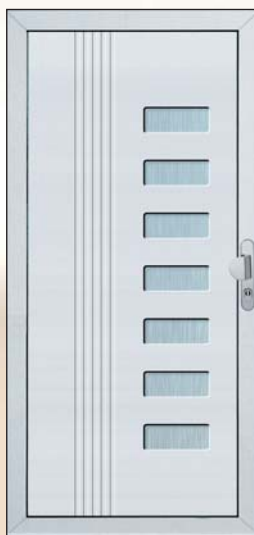

GAVA 423



GAVA 423
RAL 5003



GAVA 425
RAL 1005





GAVA 437 a
RAL 9006



GAVA 437 b
rozsdamentes
acél kombináció



GAVA 437c
RAL 3003 rozsdamentes acél kombináció

CIRCLES **GAVA**
aluminium

GAVA 420
GAVA 430
52-53



GAVA 430

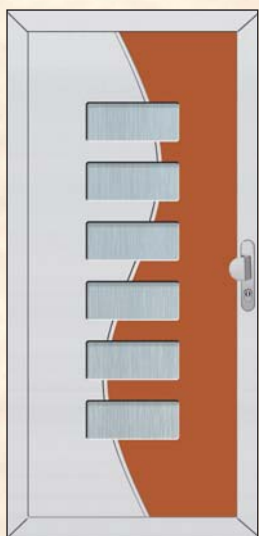

GAVA 431
RAL 8023



GAVA 432
RAL 5003



GAVA 435 a
RAL 1017
RAL 6003

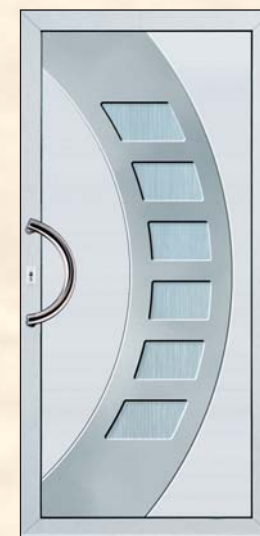

GAVA 433
RAL 9006

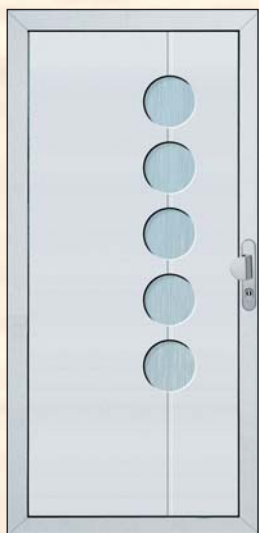

GAVA 436



GAVA 438 a
homokfúvott üveg



GAVA 439
rozsdamentes
acél kombináció



GAVA 435 b
rozsdamentes
acél kombináció



GAVA **434**

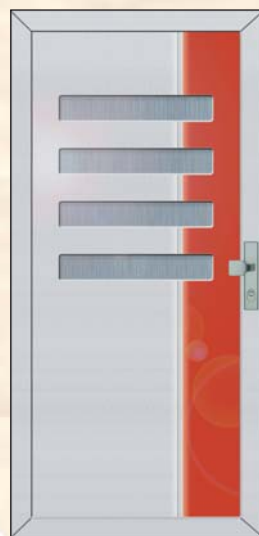

GAVA **447**
RAL 3020



GAVA **448**
RAL 8024 rozsdamentes acél kombináció



GAVA
aluminium
COMPOSITIONS

GAVA 430
GAVA 440
54-55

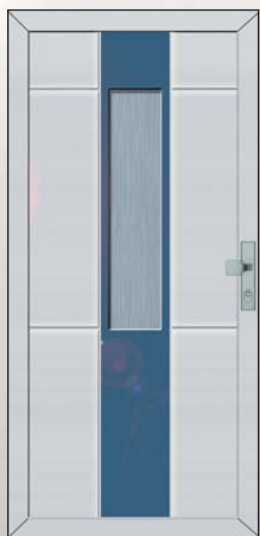

GAVA **440 a**
RAL 5021



GAVA **440 b**
RAL 5003
rozsdamentes
acél kombináció

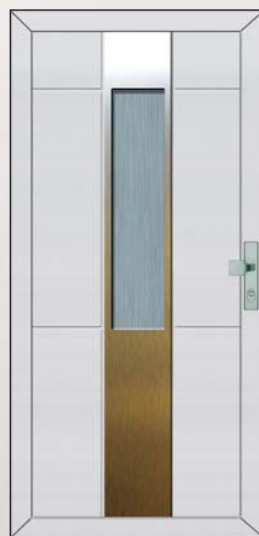

GAVA **440 b**
rozsdamentes
acél kombináció



GAVA **441 a**
RAL 3003



GAVA **441 c**
rozsdamentes
acél kombináció



GAVA **442**
rozsdamentes
acél kombináció

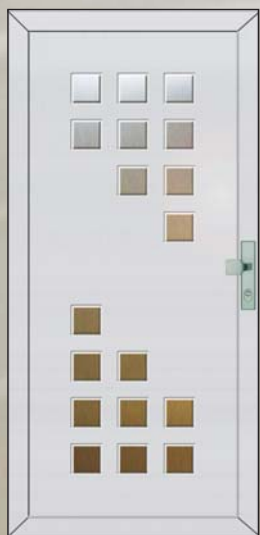

GAVA **443**
rozsdamentes
acél kombináció



GAVA **444 a**



GAVA **444 b**
rozsdamentes
acél kombináció



GAVA **445**

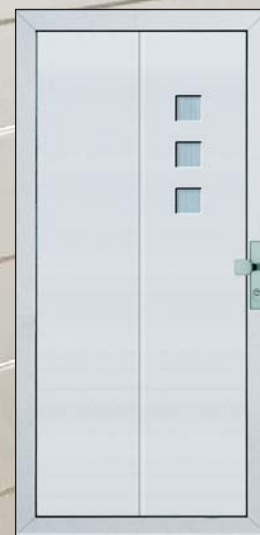

GAVA **446**



GAVA **449**
rozsdamentes
acél kombináció



GAVA
aluminium

COMPOSITIONS

GAVA 440

56-57



GAVA 452 a
rozsdamentes acél kombináció



GAVA 452 b
RAL 1017,
RAL 9006





GAVA 450 b
RAL 5003
rozsdamentes
acél kombináció

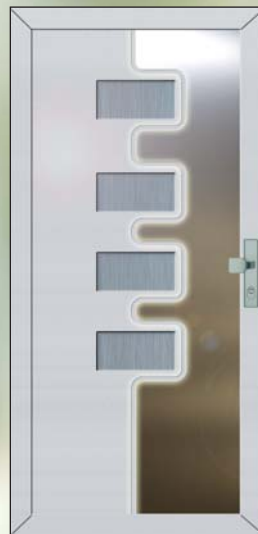

GAVA 453 b
rozsdamentes
acél kombináció



GAVA 454 b
rozsdamentes
acél kombináció

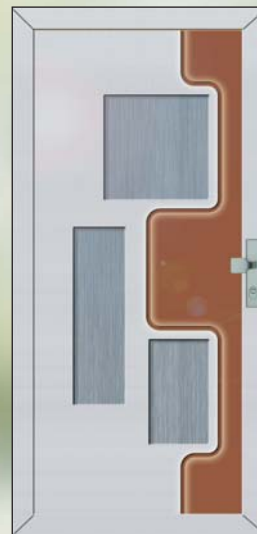

GAVA 455
RAL 8023

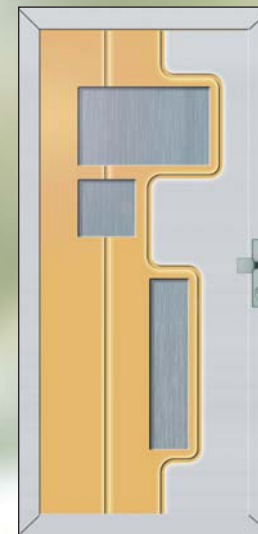

GAVA 456
RAL 1017



GAVA 451
rozsdamentes
acél kombináció
homokfúvott üveg



GAVA 457
RAL 5021



GAVA 457
RAL 5021

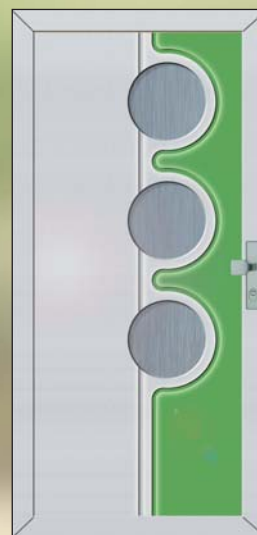

GAVA 458
RAL 6018

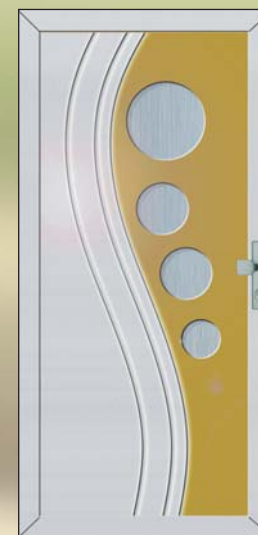

GAVA 459
RAL 1005

SOFT
GAVA
aluminium

GAVA 450

58-59



GAVA **460**

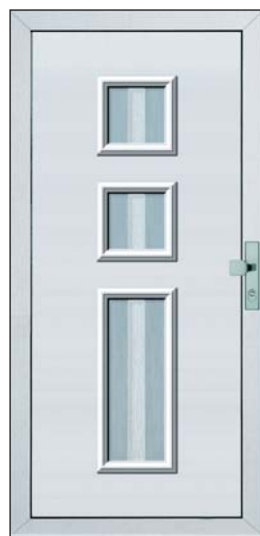

GAVA **461**
homokfúvott
üveg

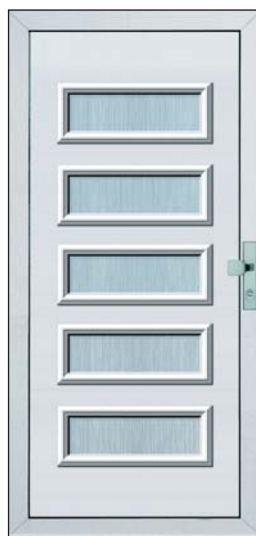

GAVA **462**



GAVA **464a**



GAVA **464b**

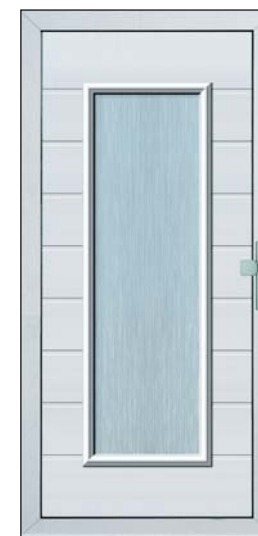

GAVA **465**

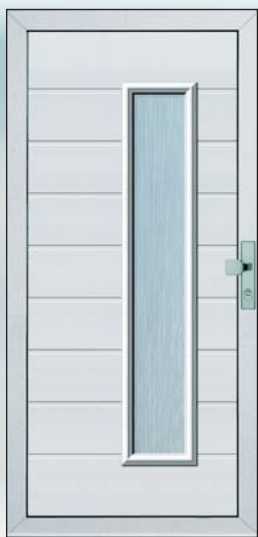

GAVA **466**

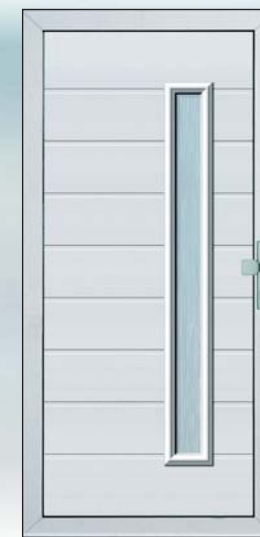

GAVA **467**

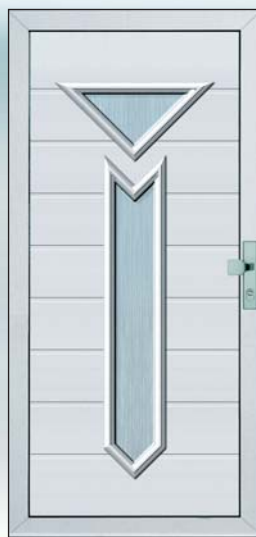

GAVA **468**

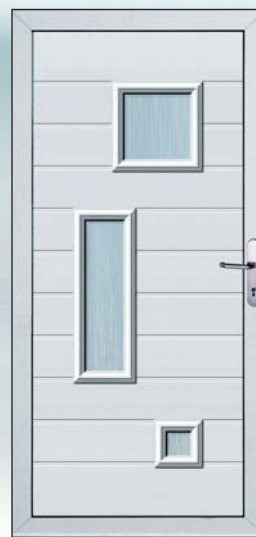

GAVA **469**



GAVA **463a**



GAVA **463b**
RAL 9006
RAL 9016



GAVA 463c

rozsdamentes
acél kombináció



PROFILES **GAVA**
aluminium

GAVA 460

60-61

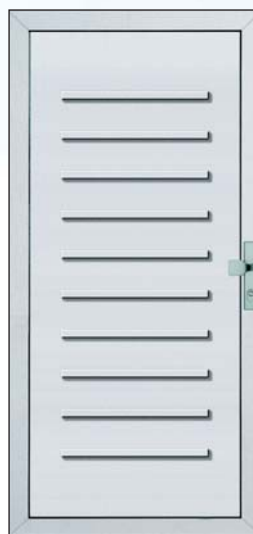

GAVA **470a**



GAVA **470b**
RAL 5003



GAVA **476**
RAL 9007

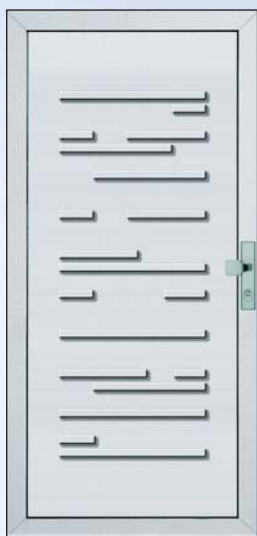

GAVA 471

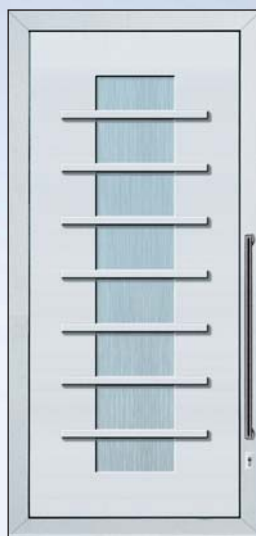

GAVA 472

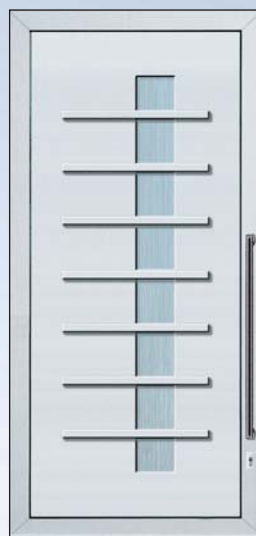

GAVA 473

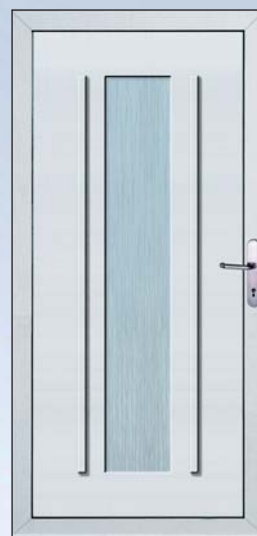

GAVA 474 a

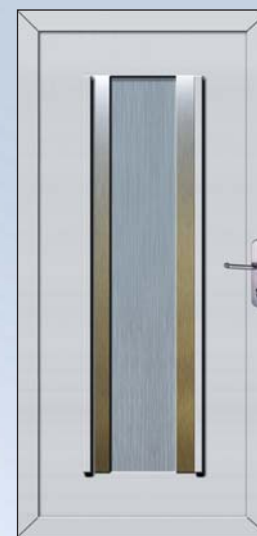

GAVA 474 b
rozsdamentes
acél kombináció

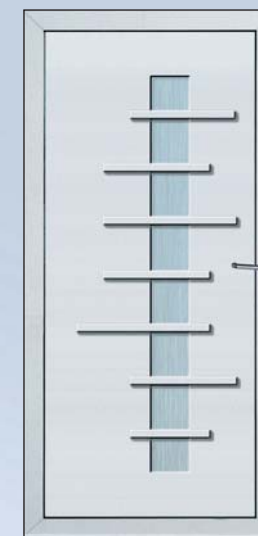

GAVA 479



GAVA 475



GAVA 475 b
RAL 3003,
RAL 9016

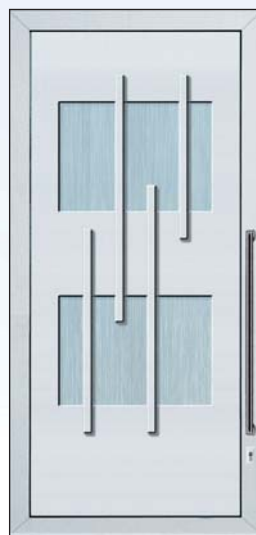

GAVA 478



GAVA 477



GAVA 483

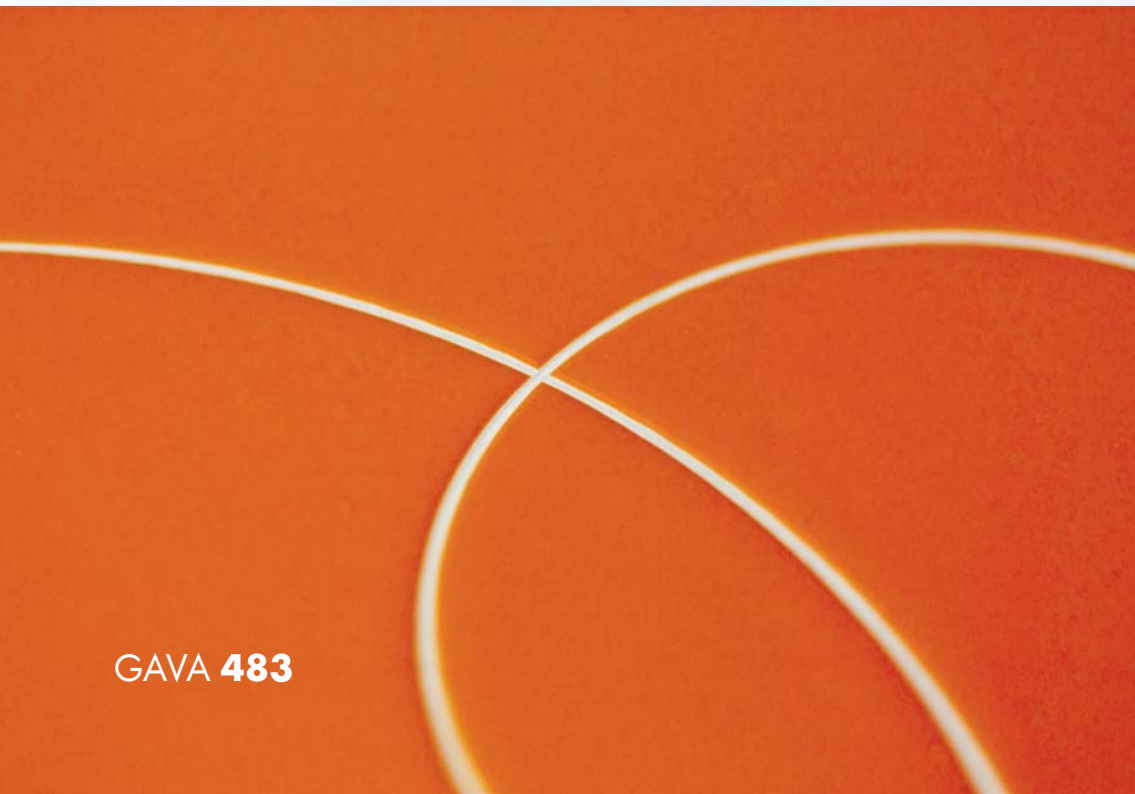

GAVA 483

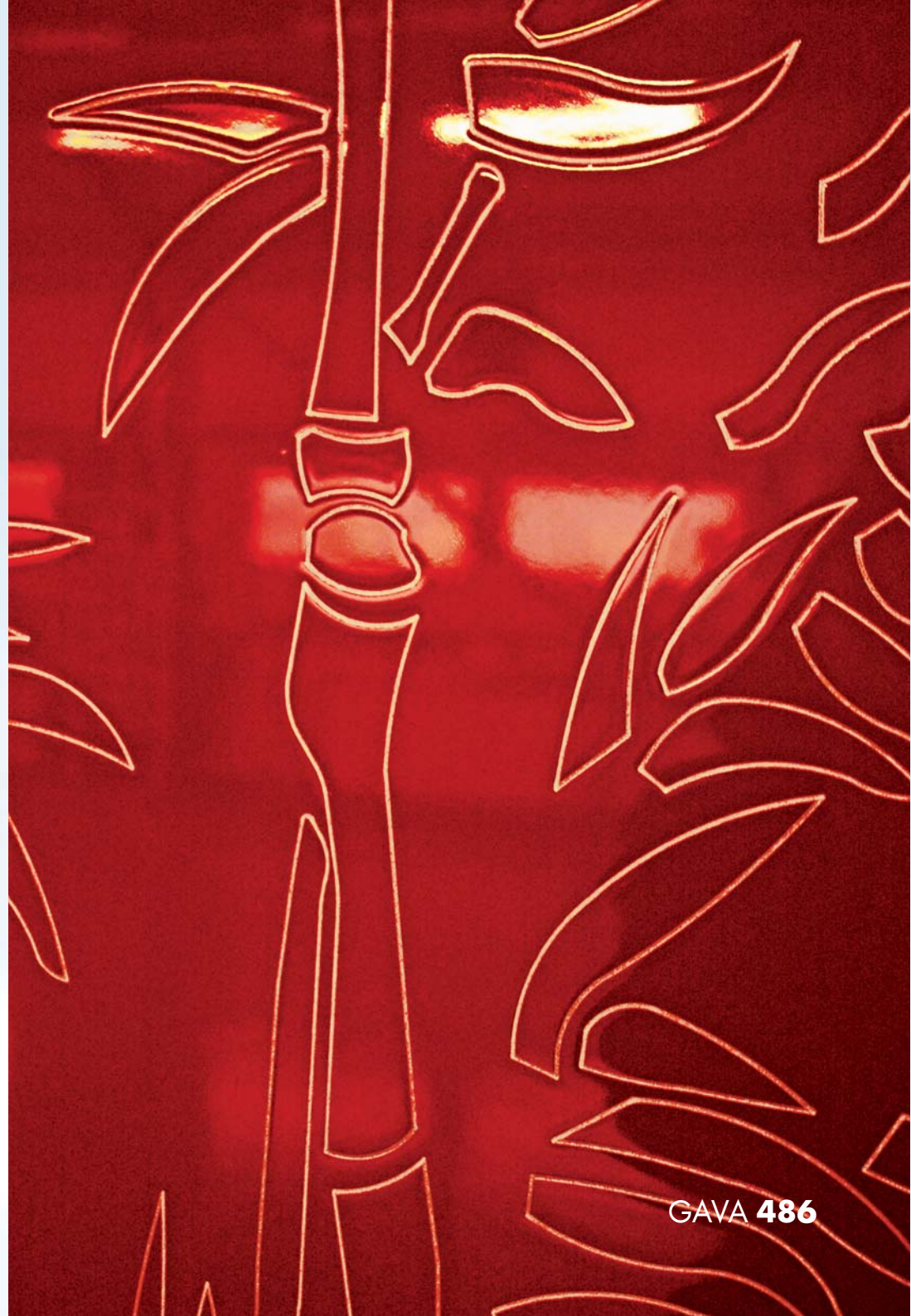

GAVA 486

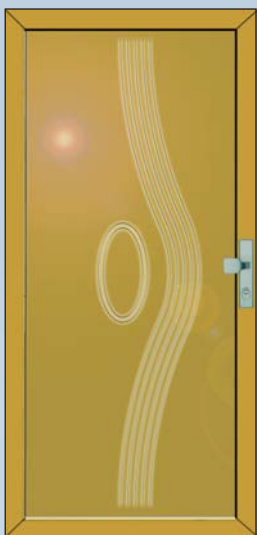

GAVA **480**
RAL 1005



GAVA **481**
RAL 3003



GAVA **481**
RAL 5003



GAVA **486**
RAL 5003

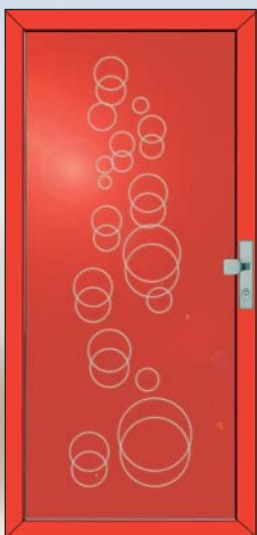

GAVA **483**
RAL 3020



GAVA **482**
RAL 5003



GAVA **482**
RAL 5021



GAVA **486**
RAL 3003

NATURE INSPIRATION **GAVA** aluminium

GAVA 480
64-65



GAVA 484a
RAL 8024
rozsdamentes
acél kombináció



GAVA 487
RAL 5003



GAVA 487a
RAL 6003
rozsdamentes
acél kombináció



GAVA 487a
RAL 8024
rozsdamentes
acél kombináció

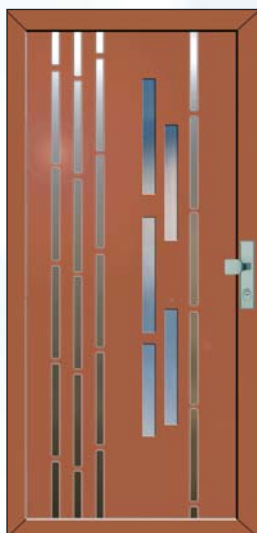

GAVA 488a
RAL 8023
rozsdamentes
acél kombináció



GAVA 488a
RAL 1005
rozsdamentes
acél kombináció



GAVA 488a
RAL 1017
rozsdamentes
acél kombináció



GAVA 485
RAL 5003



GAVA 485
RAL 1005



GAVA **487a**

RAL 3003,

rozsdamentes acél kombináció



NATURE INSPIRATION **GAVA**
aluminium

GAVA 480
66-67



1000	1013	1024	2004	3004	3017
1001	1014	1027	2008	3005	3018
1002	1015	1028	2009	3007	3020
1003	1016	1032	2010	3009	3022
1004	1017	1033	2011	3011	3027
1005	1018	1034	2012	3012	3031
1006	1019	2000	3000	3013	4001
1007	1020	2001	3001	3014	4002
1011	1021	2002	3002	3015	4003
1012	1032	2003	3003	3016	4004

GAVA aluminium színválaszték RAL színskála szerint

4005	5005	5017	6002	6012	6022	7000	7011	7030	7040	8008	8024
4006	5007	5018	6003	6013	6024	7001	7012	7031	7042	8011	8025
4007	5008	5019	6004	6014	6025	7002	7013	7032	7043	8012	8028
4008	5009	5020	6005	6015	6026	7003	7015	7033	7044	8014	9001
4009	5010	5021	6006	6016	6027	7004	7016	7034	8000	8015	9002
5000	5011	5022	6007	6017	6028	7005	7021	7035	8001	8016	9003
5001	5012	5023	6008	6018	6029	7006	7022	7036	8002	8017	9004
5002	5013	5024	6009	6019	6032	7008	7023	7037	8003	8019	9005
5003	5014	6000	6010	6020	6033	7009	7024	7038	8004	8022	9006
5004	5015	6001	6011	6021	6034	7010	7026	7039	8007	8023	9007

GAVA aluminium

Technikai adatok alumínium panelekhez:

Ajtópanelek felülete minőségi porfestékkel, porszórással készülnek, kiválasztott RAL színek alapján.

Lehetőség van rozsdamentes szálcsiszolt acél kombinációra.

Maximális méretek:

- STANDARD: 1000mm × 2000mm
- Egyedi: 1250mm × 2500mm

Részletes méreteket a www.gavaplast.sk honlapon talál.

Merevítések:

- XPS
- XPS + acéllemez

Ajtópanelek vastagsága:

- Standard vastagság: 24mm, 34mm, 36mm, 44mm
- Egyedi vastagságok: 30mm, 32mm, 40mm,stb., egyeztetés alapján gyárthatók

Hőátbocsátási tényezők:

- 24 mm vastag: XPS Styrodur 24 $u= 1,11 \text{ W.m}^{-2}.\text{K}^{-1}$
- 24 mm vastag: XPS Styrodur 24 + acél lemez
 $u= 1,37 \text{ W.m}^{-2}.\text{K}^{-1}$
- 34 mm vastag: XPS Styrodur 34 $u= 0,94 \text{ W.m}^{-2}.\text{K}^{-1}$
- 36 mm vastag: XPS Styrodur 36 $u= 0,89 \text{ W.m}^{-2}.\text{K}^{-1}$
- 44 mm vastag: XPS Styrodur 44 $u= 0,74 \text{ W.m}^{-2}.\text{K}^{-1}$



GAVA 487a

RAL 8024, rozsdamentes acél kombináció

GAVA 891
aranytölgy



GAVA 754
aranytölgy



GAVA hpl

70-71

AJTÓBETÉTEK MŰANYAG ÉS ALUMÍNÍUM PROFILRENDSZEREKHEZ



GAVA **691**, aranytölgy,
alu kombináció



GAVA **691**
nussbaum,
alu kombináció



GAVA **690**
alu kombináció

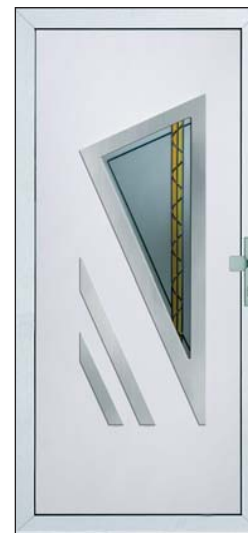

GAVA **691**
DecorGlass 'Sinus'
alu kombináció

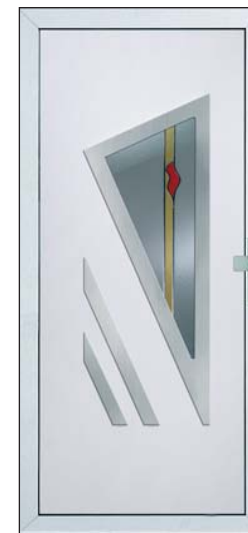

GAVA **691**
DecorGlass 'Wawe'
alu kombináció



GAVA **691**
DecorGlass 'Washington'
alu kombináció

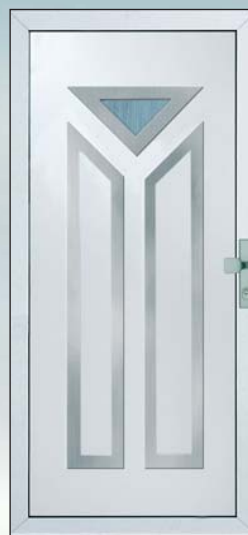

GAVA **651**
alu kombináció



GAVA **652**
aranytölgy,
alu kombináció



652/2
aranytölgy,
alu
kombináció



GAVA **652**
eiche dunkel,
alu kombináció



GAVA **652**
nussbaum,
alu kombináció



GAVA 652
DecorGlass 'Forum',
alu kombináció

GAVA 652/2
DecorGlass 'Forum',
alu kombináció



GAVA hpl

GAVA 690
GAVA 650
72-73



GAVA 832
eiche dunkel,
DecorGlass 'Vektor'
alu kombináció

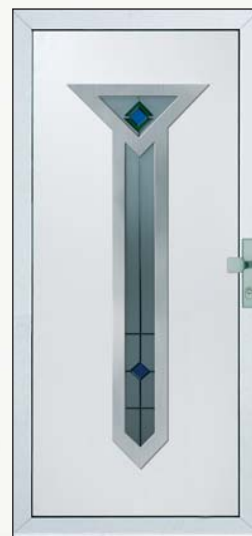

GAVA 832
DecorGlass
'Briliant'
alu kombináció



GAVA 832, eiche dunkel,
DecorGlass 'Kompass'
alu kombináció



GAVA 831
alu kombináció



GAVA 832
aranytölgy,
alu kombináció

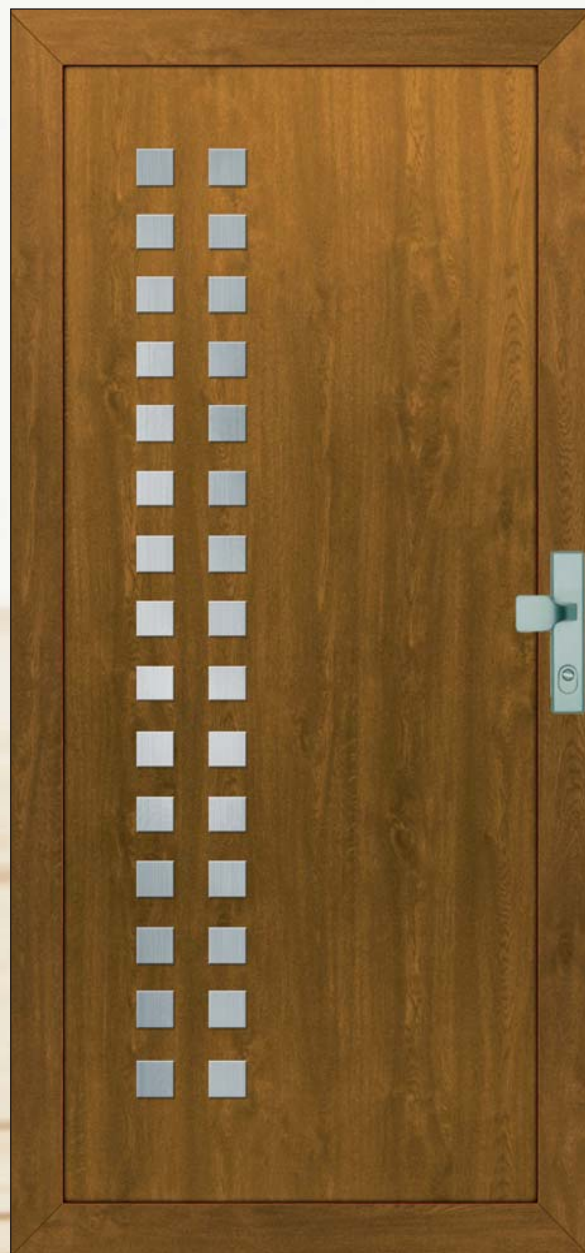

GAVA 864
aranytölgy, alu kombináció



GAVA 860
alu kombináció

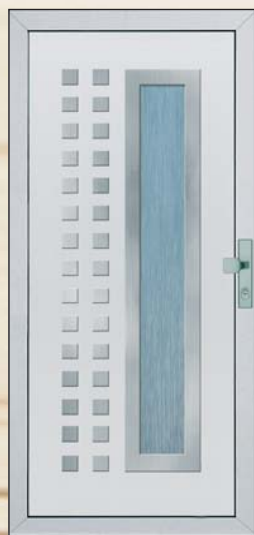

GAVA 861
alu kombináció

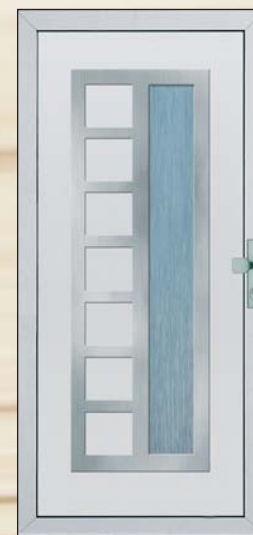

GAVA 862
alu kombináció



GAVA 863
nussbaum,
alu kombináció

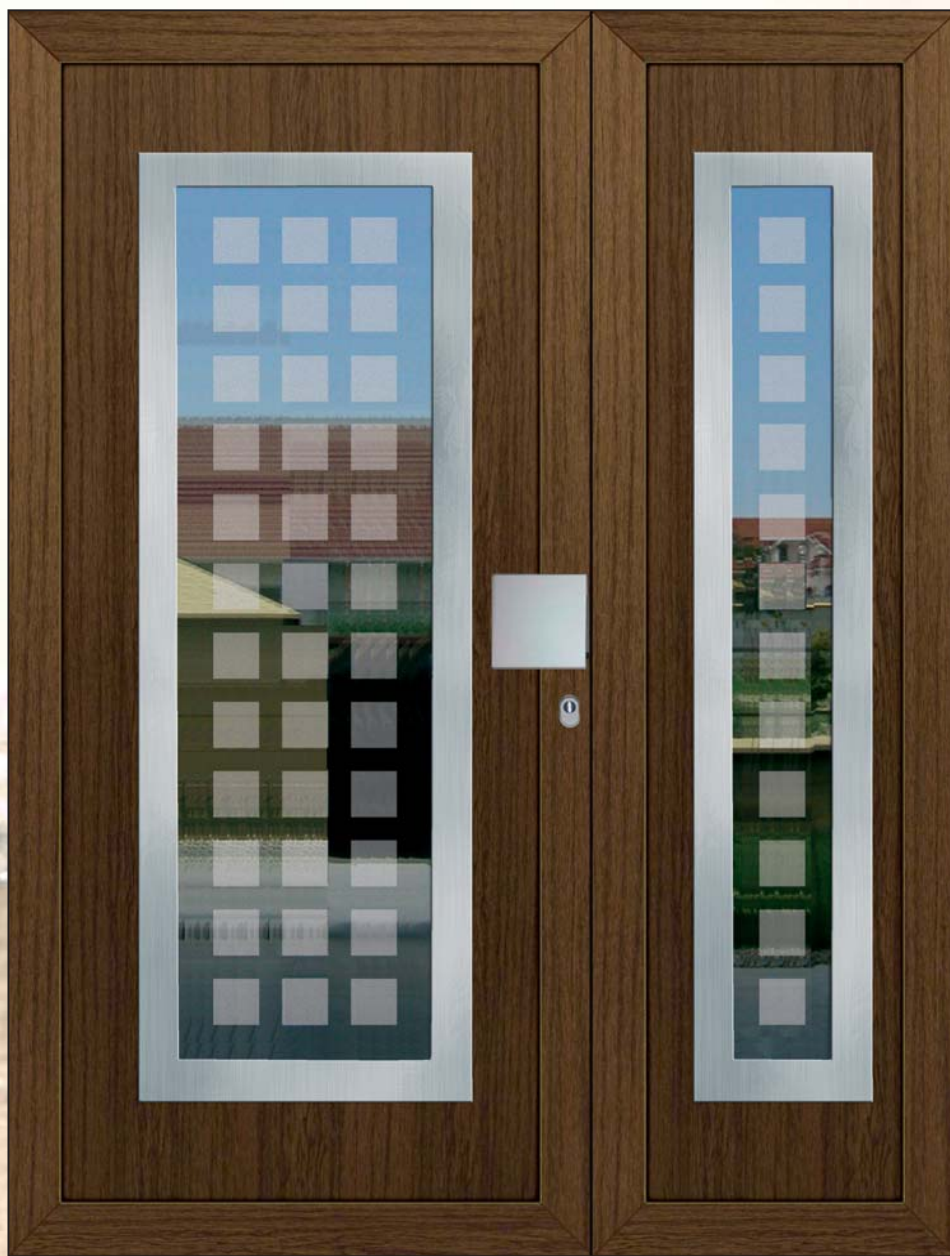

GAVA 701 eiche dunkel,
homokfűvott üveg négyzetek,
alu kombináció

GAVA 701/2 eiche dunkel,
homokfűvott üveg négyzetek,
alu kombináció



GAVA 701
nussbaum,
DecorGlass
'Light Ray',
alu kombináció



GAVA 701
eiche dunkel,
alu kombináció

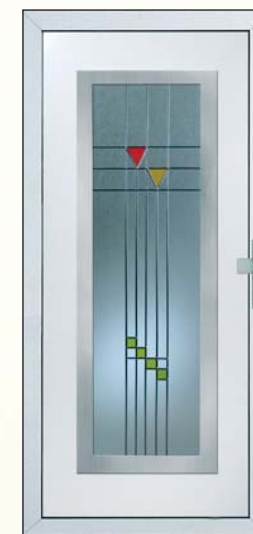

GAVA 701
DecorGlass 'Progres',
alu kombináció



GAVA 702
nussbaum,
alu kombináció



GAVA 702
alu kombináció



GAVA **754**, aranytölgy,
alu kombináció



GAVA **752**
eiche dunkel,
alu kombináció



GAVA **753**
nussbaum,
alu kombináció

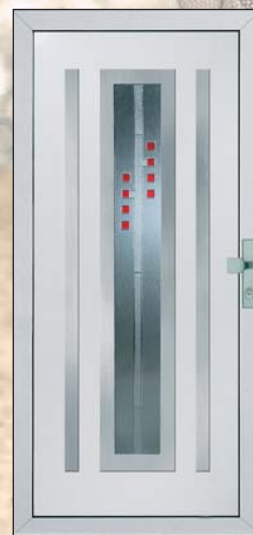

GAVA **751**
DecorGlass 'Array',
alu kombináció





GAVA **732**
alu kombináció



GAVA **731** **731/2**
aranytölgy, alu kombináció

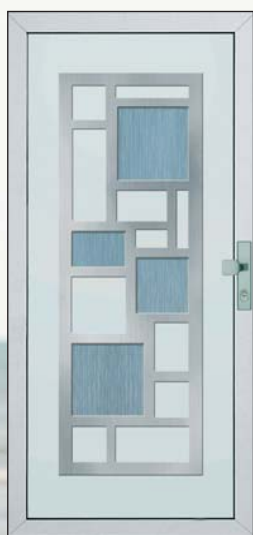

GAVA **741**
alu kombináció



GAVA **742**
nussbaum, alu kombináció



GAVA **872**
Decor Glass 'Metric'
alu kombináció



GAVA **871**,
aranytölgy,
alu kombináció



GAVA **873**,
nussbaum,
alu kombináció



GAVA **872**
DecorGlass 'Flower',
alu kombináció



GAVA **872**
DecorGlass 'Harmony',
alu kombináció



GAVA hpl

GAVA 730

GAVA 740

GAVA 870

78-79



GAVA 892
eiche dunkel, DecorGlass 'Linea',
alu kombináció



GAVA 811
DecorGlass 'Carnival',
alu kombináció



GAVA 811
DecorGlass 'Arena',
alu kombináció



GAVA 811
aranytölgy,
DecorGlass 'Figaro',
alu kombináció



GAVA 811
eiche dunkel,
alu kombináció

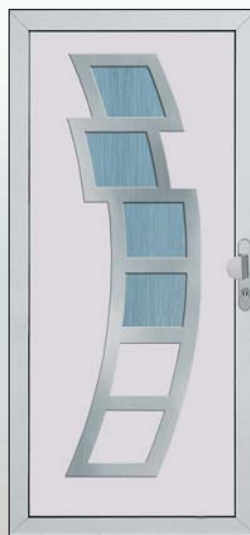

GAVA 891
alu kombináció

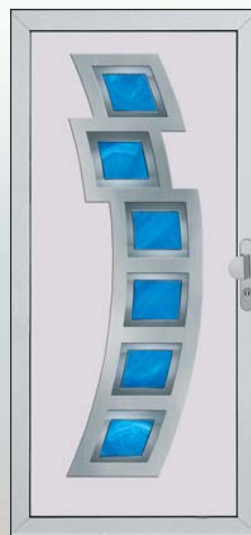

GAVA 892
DecorGlass 'Plane',
alu kombináció



GAVA 893
nussbaum,
alu kombináció



GAVA 800
eiche dunkel,
alu kombináció

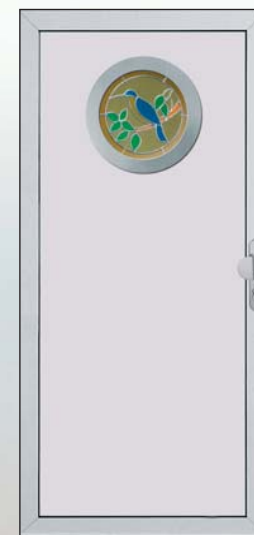

GAVA 801
DecorGlass 'Bird',
alu kombináció



GAVA 811
nussbaum, DecorGlass 'Game', alu kombináció

GAVA 811

GAVA hpl

GAVA 890
GAVA 800
GAVA 810

80-81



GAVA 916
nussbaum



GAVA 912a,
alu kombináció

912a/2



GAVA 912
aranytölgy

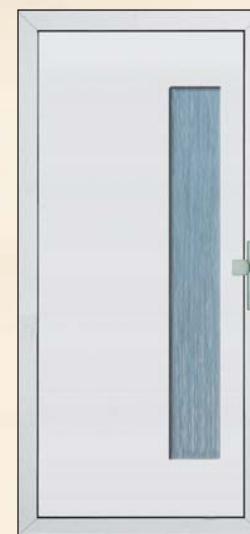

GAVA 913

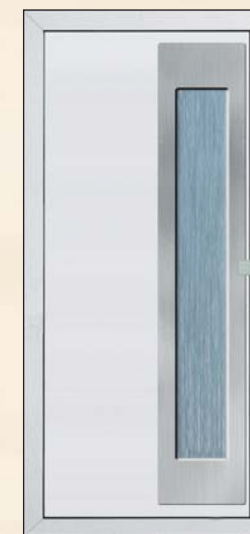

GAVA 913a
alu kombináció



GAVA 916
aranytölgy

916/2
aranytölgy



GAVA 964a
eiche dunkel,
alu kombináció

964a/2
eiche dunkel,
alu kombináció



GAVA 964
nussbaum



GAVA 964b
alu kombináció

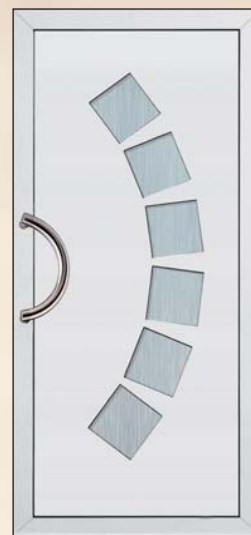

GAVA 941



GAVA 961a
alu kombináció



GAVA 961
nussbaum



GAVA 939
aranytölgy



GAVA 917
aranytölgy

917/2
aranytölgy

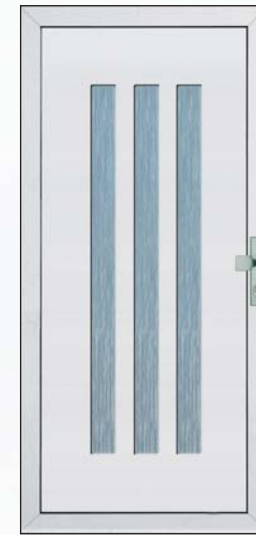

GAVA 918

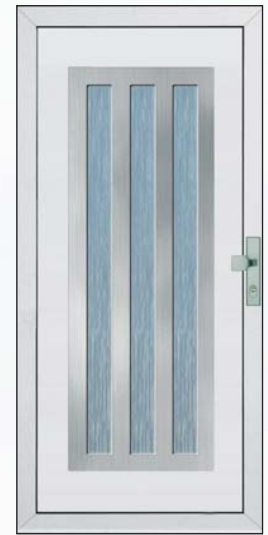

GAVA 918a
alu kombináció

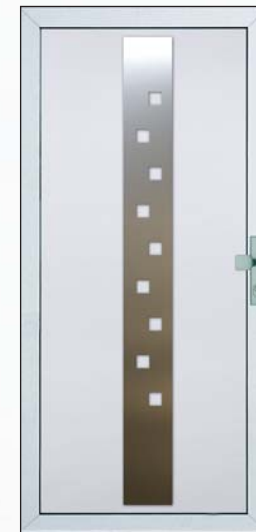

GAVA 950
alu kombináció

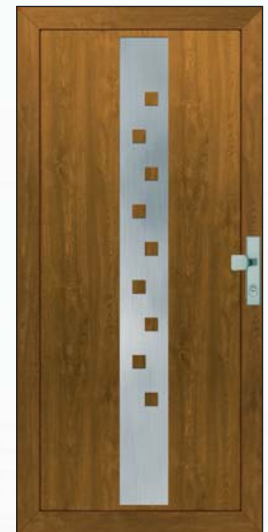

GAVA 950
aranytölgy
alu kombináció



GAVA 949
alu kombináció,
fatörzs üveggel



GAVA 956
aranytölgy, alu kombináció,
fatörzs üveggel



GAVA 951
eiche dunkel



GAVA 955



GAVA 955
alu kombináció,
fatörzs üveggel

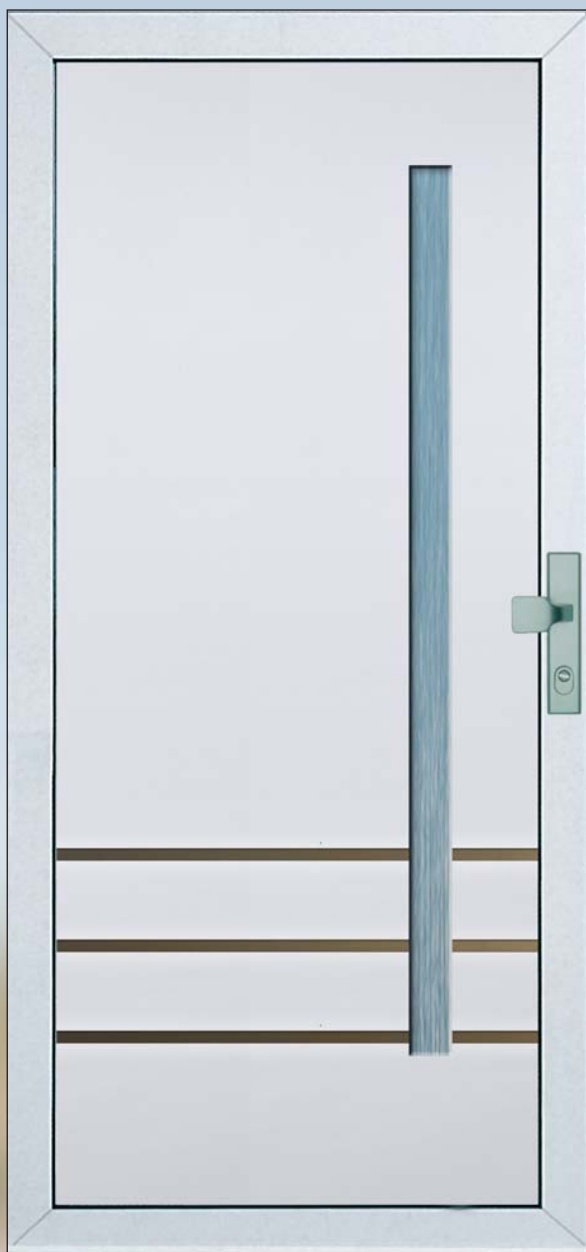

GAVA 919
alu intarzia



GAVA 945
alu intarzia
alu kombináció



GAVA 945
eiche dunkel,
alu intarzia
alu kombináció



GAVA 919
eiche dunkel,
alu intarzia

GAVA 919/2
eiche dunkel,
alu intarzia



GAVA 947
nussbaum,
alu intarzia
fatörzs üveggel



GAVA 946
aranytölgy,
alu intarzia
fatörzs üveggel

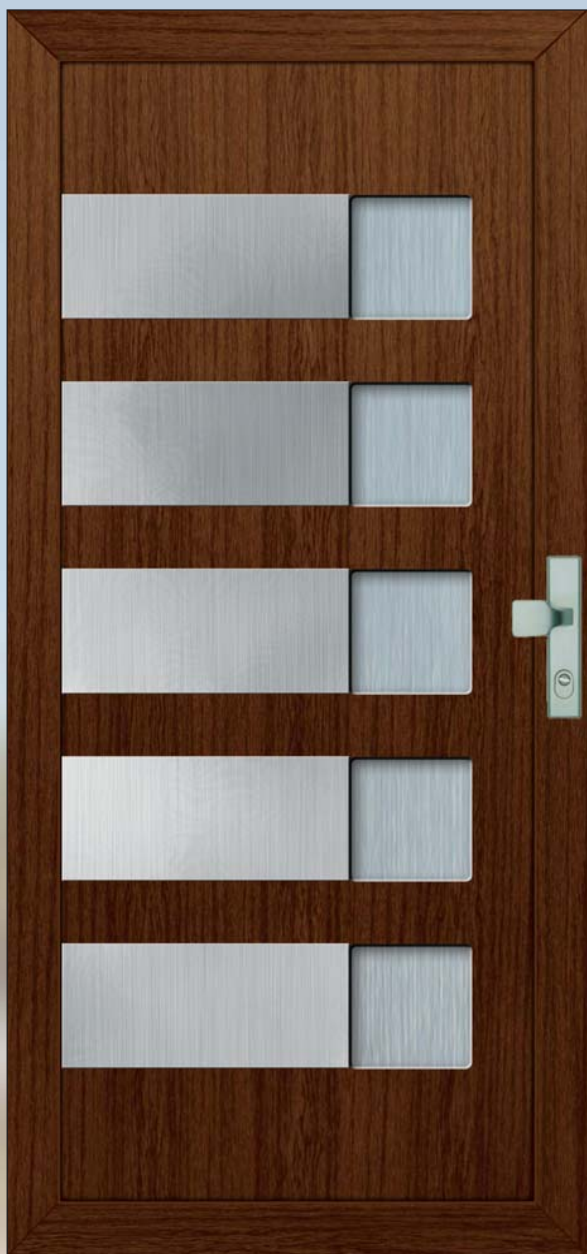

GAVA 929a
eiche dunkel,
alu kombináció,
fatörzs üveggel

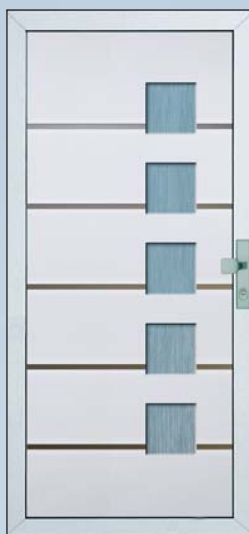

GAVA 928
alu intarzia,
fatörzs üveggel

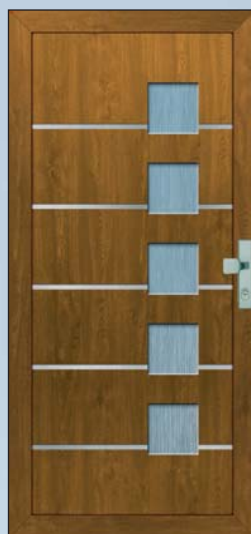

GAVA 928
aranytölgy
alu intarzia,
fatörzs üveggel



GAVA 926
nussbaum,
fatörzs üveggel



GAVA hpl INTARZIÁK

GAVA 900
újdivóság
86-87



GAVA 900 - Részletes kép alumínium kombinációról és az alumínium intarziáról

- Alu kombináció: HPL felületén ráragasztott eloxált alumínium részek (pl.: négyzetek, keret, vonal, csíkok)
- Alu intarzia: eloxált alumínium csíkok besüllyesztve a HPL anyagába, egy síkban



GAVA 900
alu intarzia
alu kombináció



GAVA 900
nussbaum,
alu intarzia
alu kombináció



GAVA 901 aranytölgy,
alu intarzia
fatörzs üveggel



GAVA 948
alu intarzia
fatörzs üveggel



GAVA 953
nussbaum,
alu intarzia
fatörzs üveggel

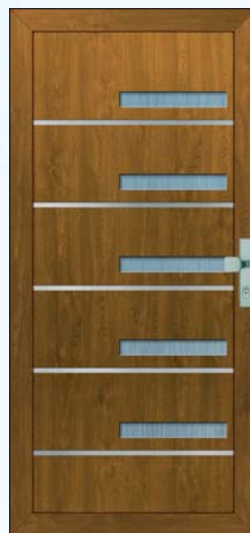

GAVA 954
aranytölgy,
alu intarzia
fatörzs üveggel



GAVA 952
eiche dunkel,
alu intarzia
fatörzs üveggel



HPL panelek színválasztéka



Palisander
Renolit 8875 05



Mooreiche
Renolit 3167 004



Sapeli
Renolit 2065 021



Mahagón
Renolit 2097 013



Macore
Renolit 3162 002



Nussbaum
Renolit 2178 007

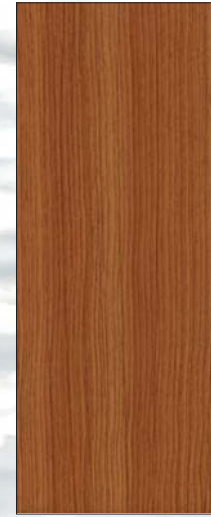

Streifendouglas
Renolit 3152 009



**Noce Sorrento
balsamico**
Hornschuch
F 439-3042



**Staufereiche
terra**
Hornschuch
F 436-2035



Eiche dunkel
Renolit 2052 089



Eiche rustikal
Renolit 3149 008

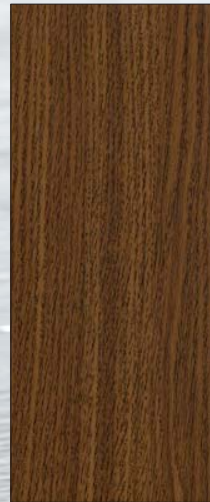

Eiche jalt
Renolit 3156003

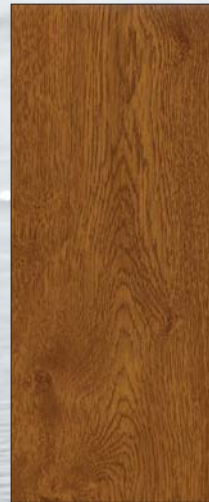

Aranytölgy
Renolit 2178 001



Eiche hell
Renolit 2052 090

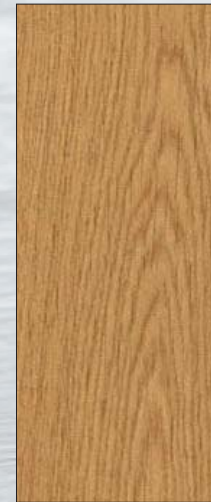

Eiche natur
Renolit 3118 076



Irish oak
Renolit 3211 005



Cherry amaretto

Hornschuch
F 425-2043



Nevada

Renolit 2167 010



Canadian

Renolit 491 95



Oregon 3

Renolit 2115 008



Oregon 4

Renolit 1192 001



Winchester

Renolit 492 40



Sierra

Renolit 2167 009



Birke rose

Hornschuch
F 436-3031



Siena rosso

Renolit 492 33



Siena noce

Renolit 492 37



Anthrazitgrau

Renolit 7016 05



Stahlblau

Renolit 515005



Schwarzbraun

Renolit 8518 05



Grau

Renolit 7155 05



**Metbursch
Aluminium**

Hornschuch
F436-1001



**Tabasco
Teak**

Renolit 2222 004

GAVA HPL (High Pressure Laminated)

Technikai adatok HPL panelekhez

HPL – gyanta alapú ajtópanel lap. Ezek az ajtólapok erősebbek, stabilabbak és széles színválasztékban kaphatók.

Fehér HPL színválaszték:

- HPL Weiss (standard fehér)
- HPL Salamander

Merevítések:

- XPS
- XPS+acéllemez

Maximális méretek: 900mm × 2150mm

Ajtópanelek vastagsága:

- Standard vastagság: 24mm, 34mm, 36mm, 44mm
- Egyedi vastagságok: 30mm, 32mm, 40mm,stb., egyeztetés alapján gyárthatók

Hőátbocsátási tényezők:

- 24 mm vastag: XPS Styrodur 24 $u = 1,04 \text{ W.m}^{-2}.\text{K}^{-1}$
- 24 mm vastag: XPS Styrodur 24 + acél lemez
 $u = 1,26 \text{ W.m}^{-2}.\text{K}^{-1}$
- 34 mm vastag: XPS Styrodur 34 $u = 0,89 \text{ W.m}^{-2}.\text{K}^{-1}$
- 36 mm vastag: XPS Styrodur 36 $u = 0,85 \text{ W.m}^{-2}.\text{K}^{-1}$
- 44 mm vastag: XPS Styrodur 44 $u = 0,71 \text{ W.m}^{-2}.\text{K}^{-1}$

- Alu kombináció: HPL felületén ráragasztott eloxált alumínium részek (pl.: négyzetek, keret, vonal, csíkok)
- Alu intarzia: eloxált alumínium csíkok besüllyesztve a HPL anyagába, 1 síkban

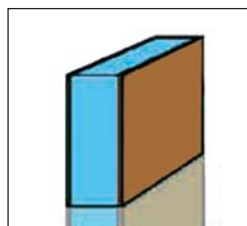

HPL

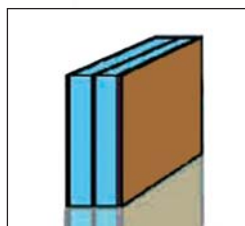

HPL+acéllemez

GAVA 928
aranytölgy, alu intarzia

Kopogtatók, levélbedobók, kitekintők



oroszlánfejes
nagy
bronz



oroszlánfejes
kicsi
bronz



urna
bronz



kör
bronz



ovál
bronz



kitekintő
ezüst
20-35 mm
31-55 mm



oroszlánfejes
nagy
rész



oroszlánfejes
kicsi
rész



urna
rész



kör
rész



ovál
rész



kitekintő
arany
20-35 mm
31-55 mm



alumínium levélbedobó
ezüst



arany színű
levélbedobó



alumínium levélbedobó
fehér



levélbedobó műanyag kerettel
ezüst



levélbedobó műanyag kerettel
arany



levélbedobó műanyag kerettel
fehér

Homokfúvott üveg minták

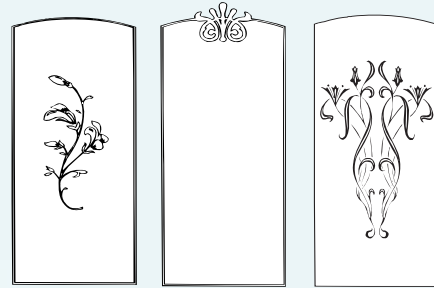

001

003

007

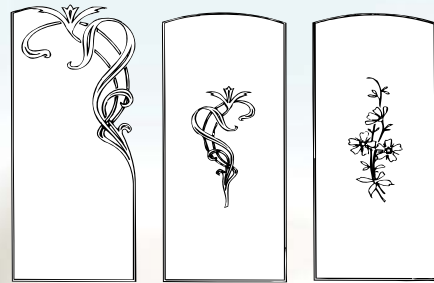

007J

007S

012

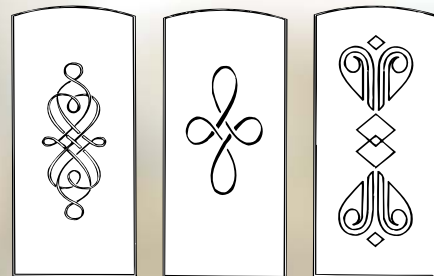

018

018D

023K

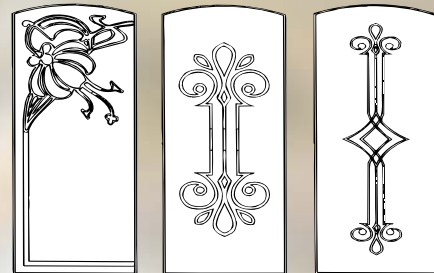

024D

026D

026F

FussingGlass



'Jeseň'



'Hviezdny prach'



'Avalon'



'Eden'



'Vlčie maky'

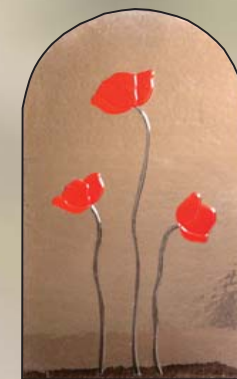

'Trojruža'

Homokfúvott üvegminták

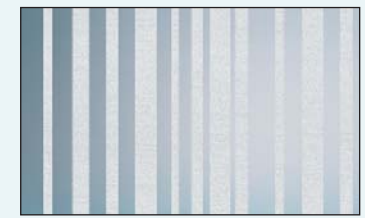

homokfúvott vonalak



homokfúvott négyzetek

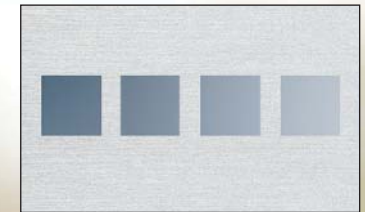

homokfúvott üveg
átlátszó négyzetek



homokfúvott négyzetek

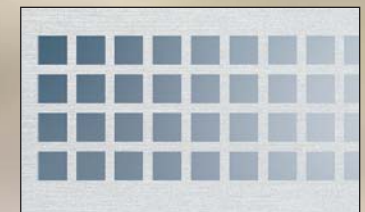

homokfúvott üveg
átlátszó négyzetek

Katedrál üvegválaszték



Fehér fatörzs



Bronz fatörzs



Matelux clearvison

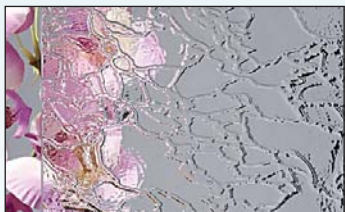

Delta číra

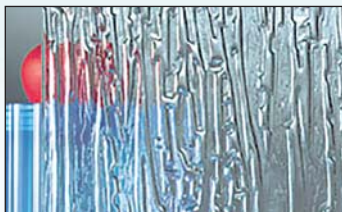

Niagara

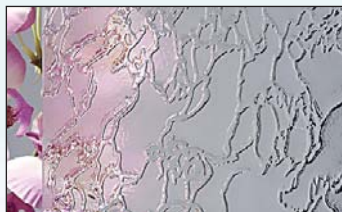

Delta matná



Altdeutsch K biely



Altdeutsch K bronz



Madera



Crepi



Katedral MIN



Silvit

Feláras üvegválaszték

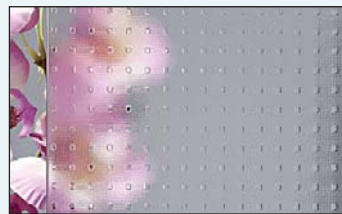

Master Carré



Master Lens

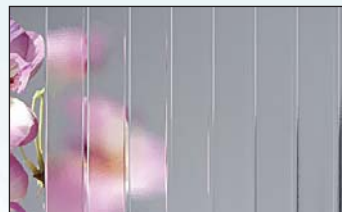

Master Ligne



Master Point

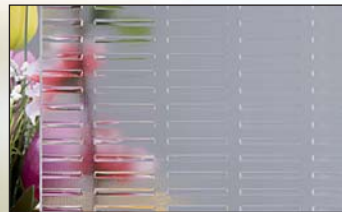

Master Ray

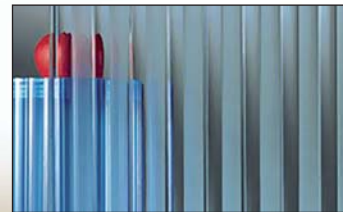

Flutes M



Square

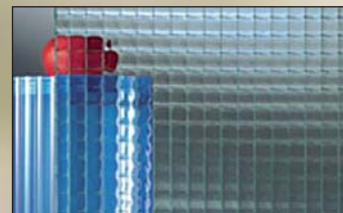

Drôto-sklo



az ötlettől
...a részletekig

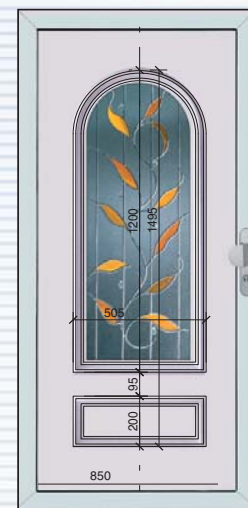
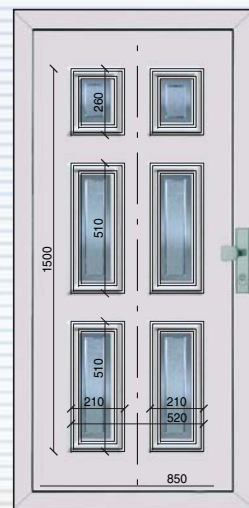

AJTÓPANELEK MÉRETEZÉSEI

GAVA plast

96-97

AJTÓBETÉTEK MŰANYAG ÉS ALUMÍNIUM PROFILRENDSZEREKHEZ

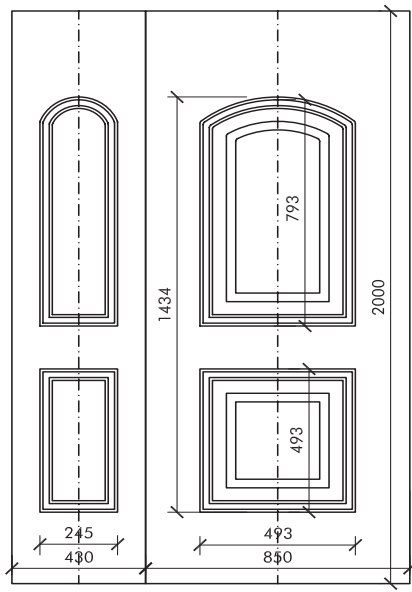

Gava 010

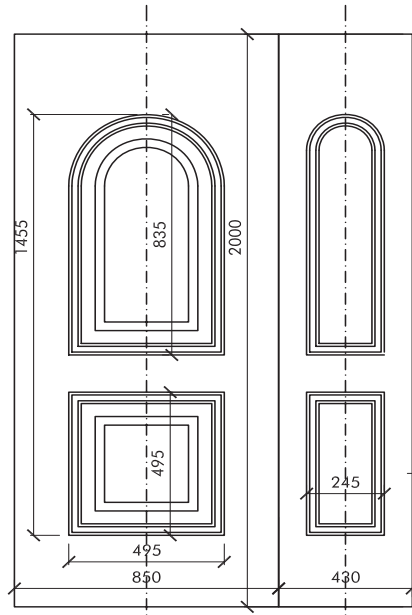

Gava 020

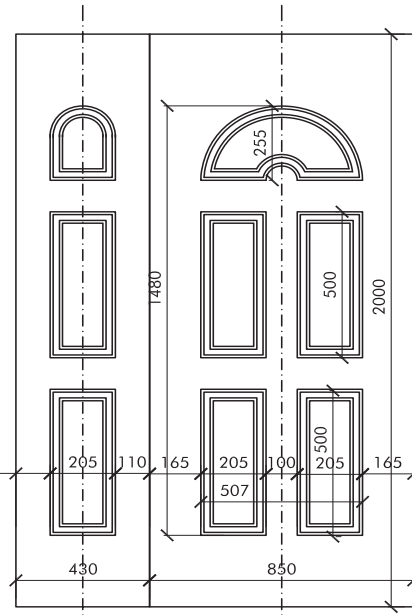

Gava 030

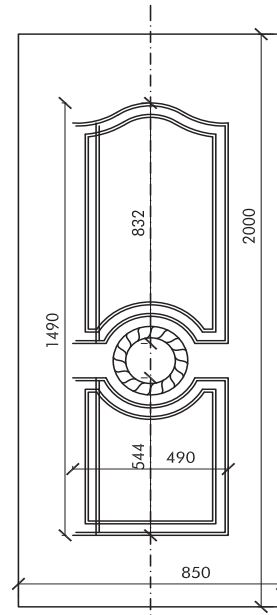

Gava 040

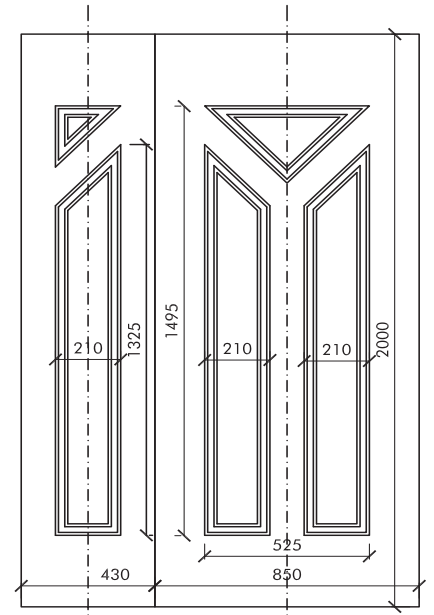

Gava 050

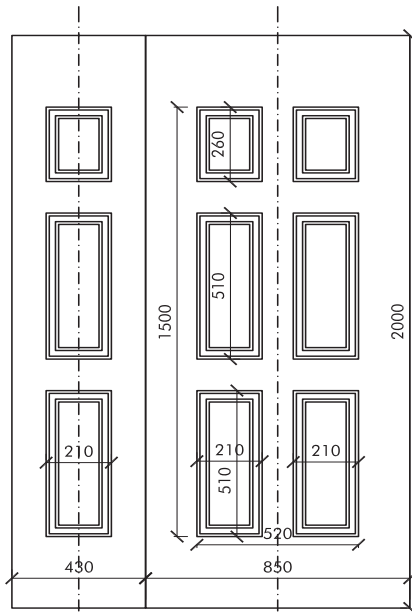

Gava 060

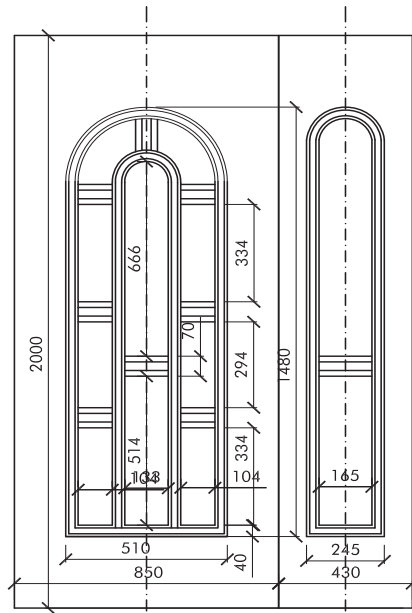

Gava 070

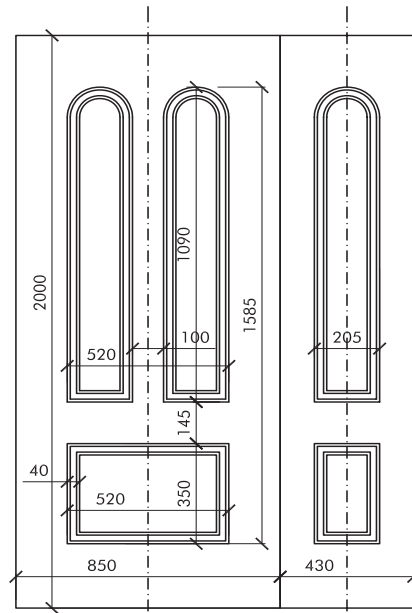

Gava 080

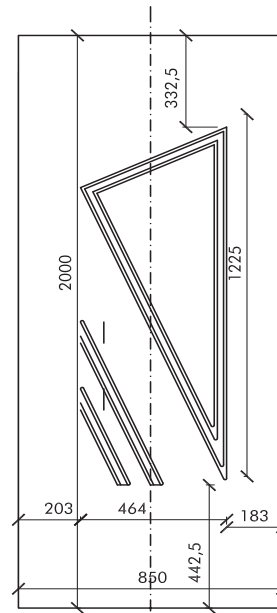

Gava 090

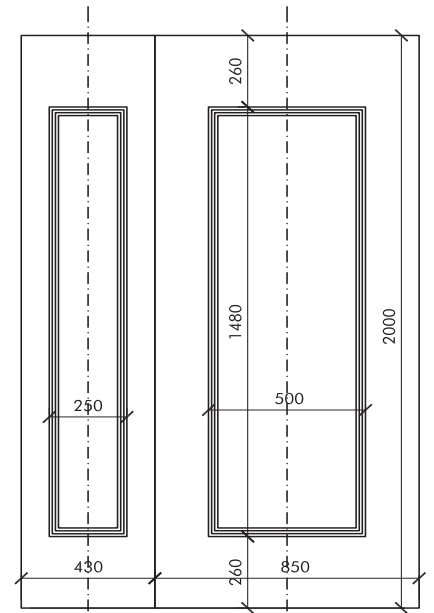

Gava 100

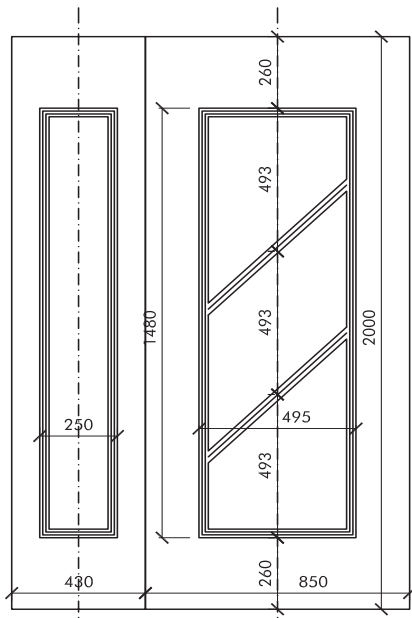

Gava 110

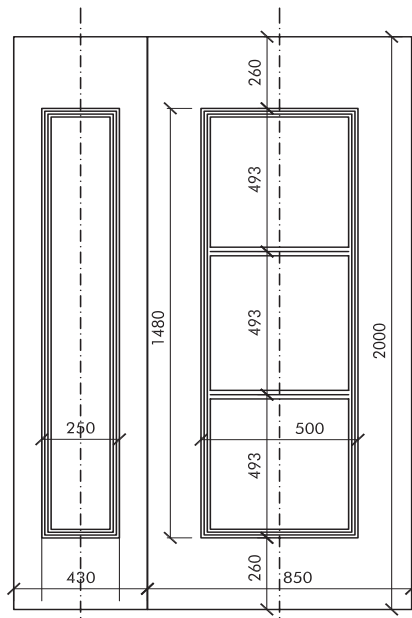

Gava 120

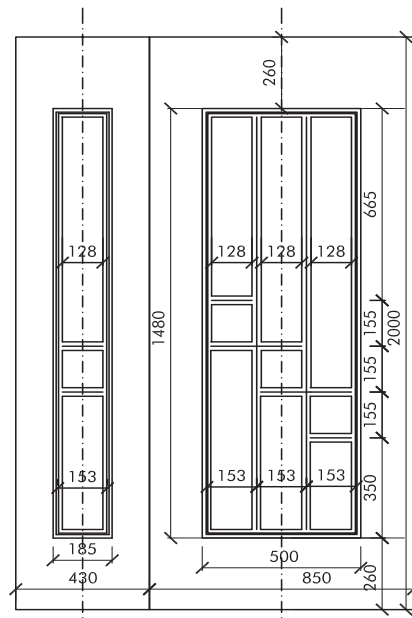

Gava 130

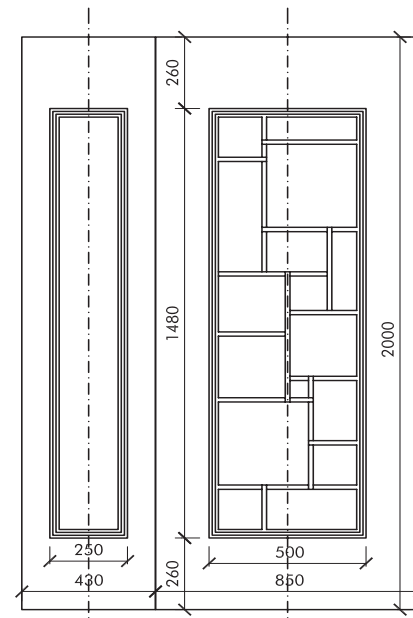

Gava 140

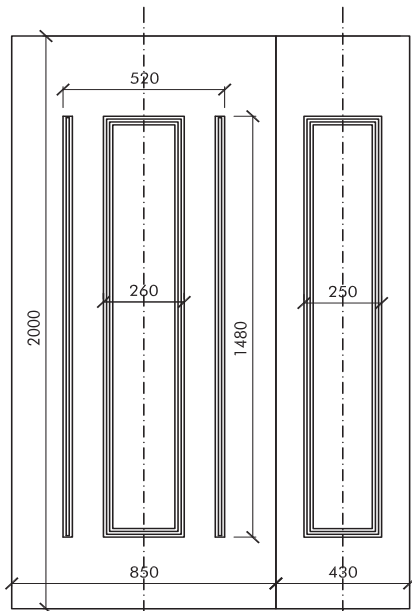

Gava 150

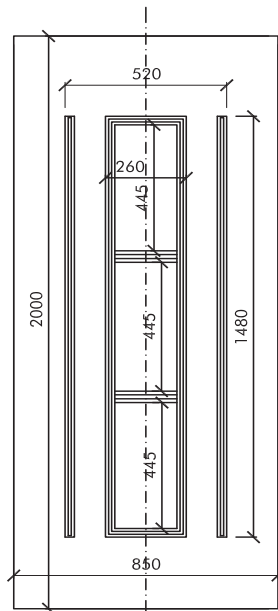

Gava 160

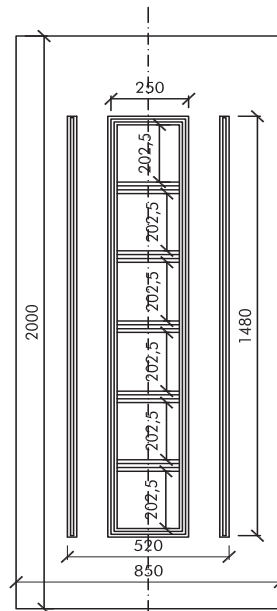

Gava 170

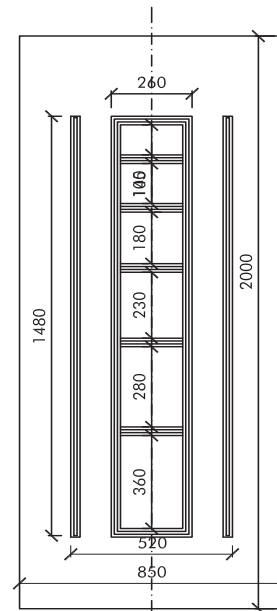

Gava 180

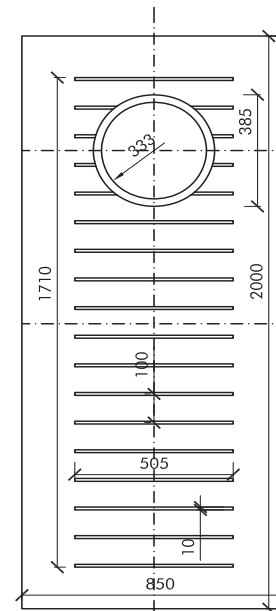

Gava 200

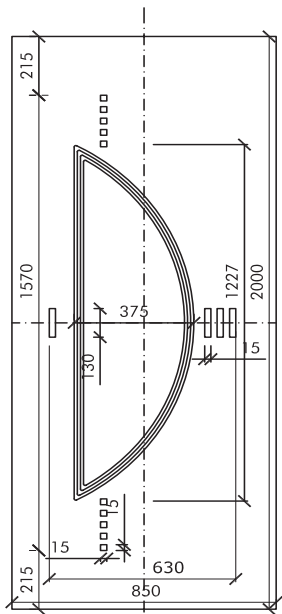

Gava 210

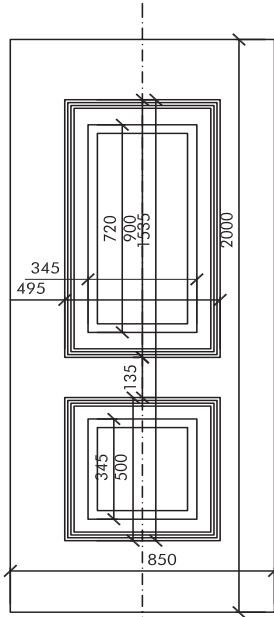

Gava 220

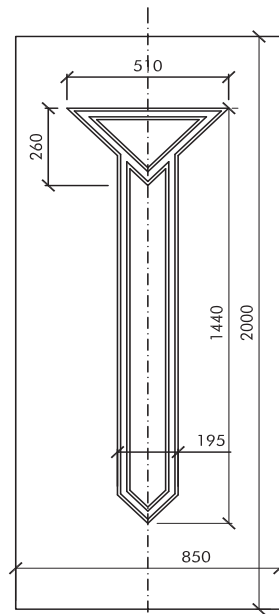

Gava 230

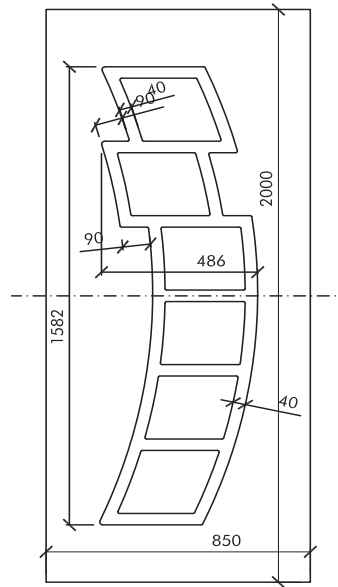

Gava 290

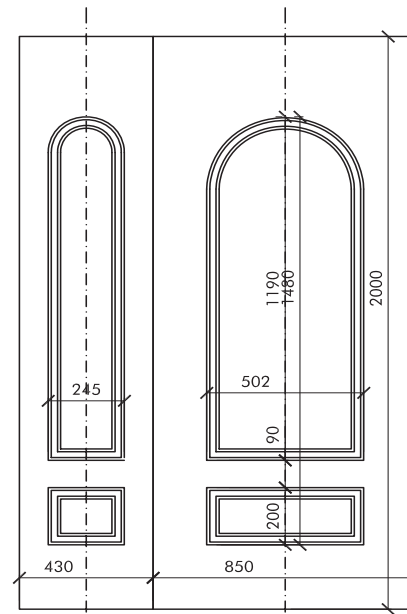

Gava 240

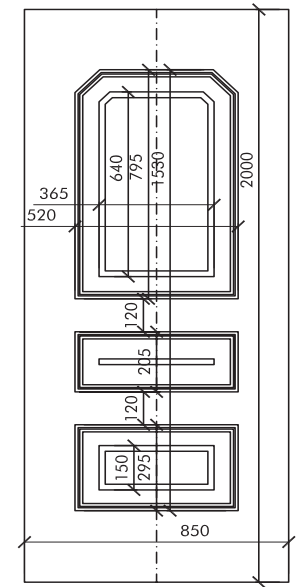

Gava 250

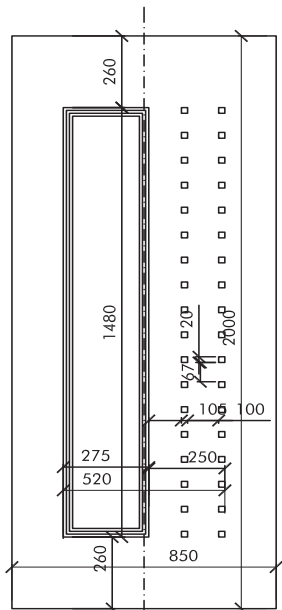

Gava 260

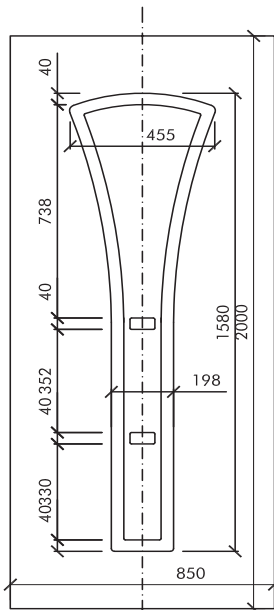

Gava 270

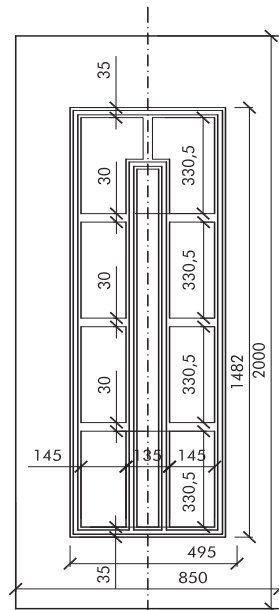

Gava 280

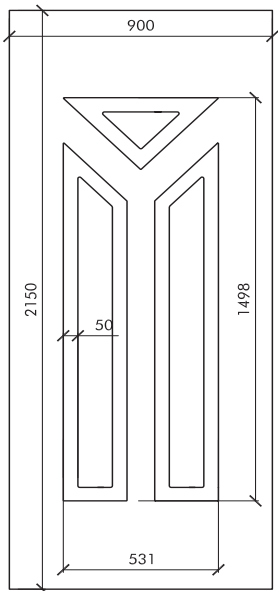

Gava 650

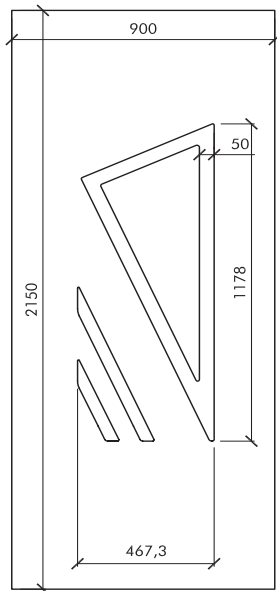

Gava 691

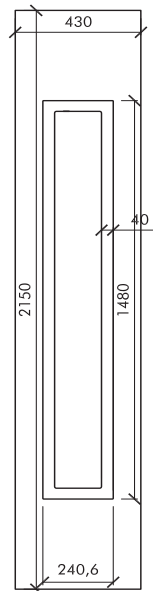

701/2

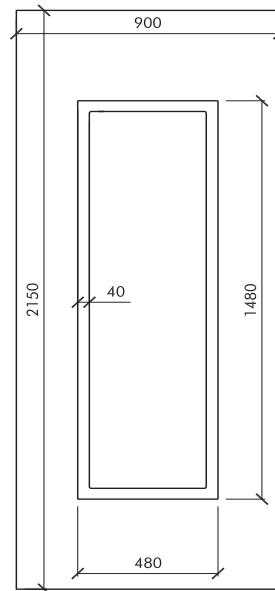

Gava 701

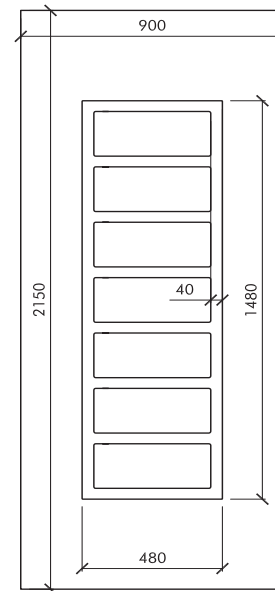

Gava 702

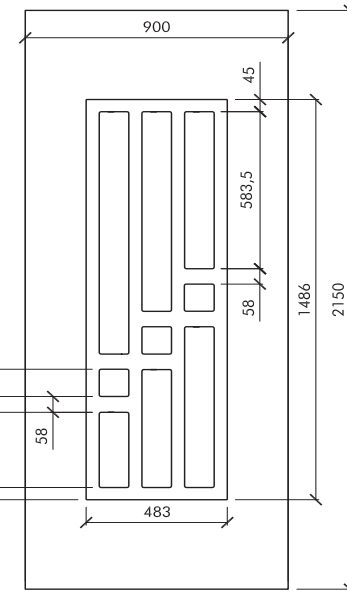

Gava 732

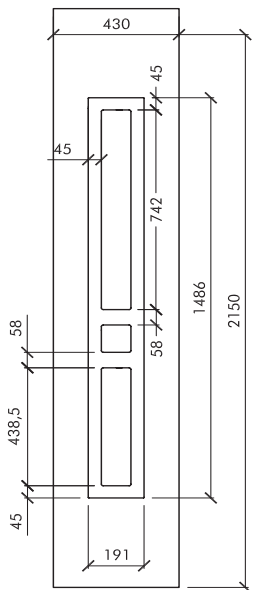

732/2

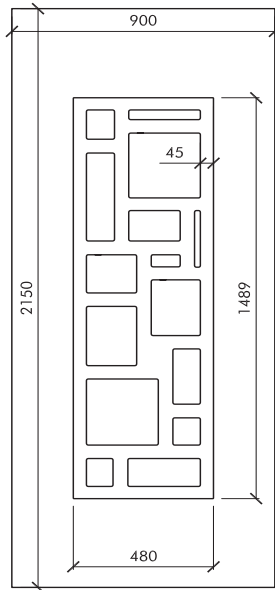

Gava 740

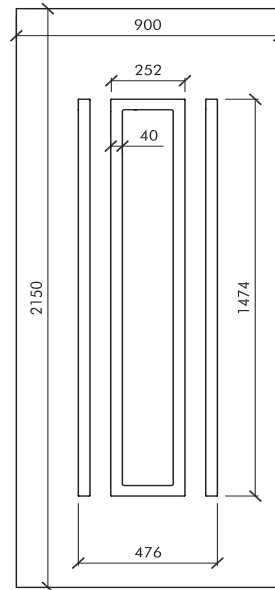

Gava 651

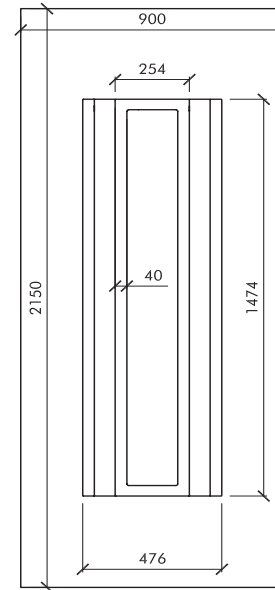

Gava 752

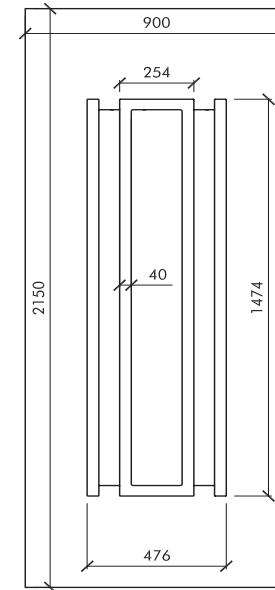

Gava 753

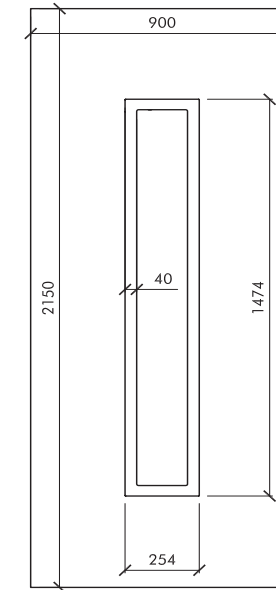

Gava 754

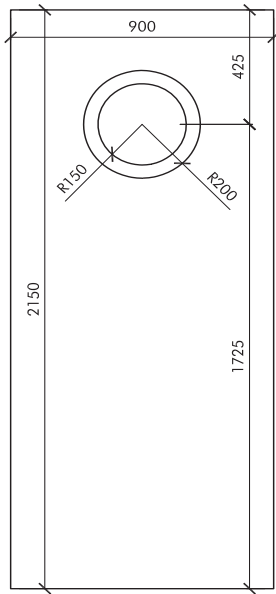

Gava 800

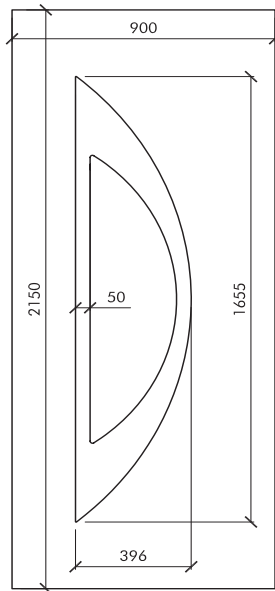

Gava 811

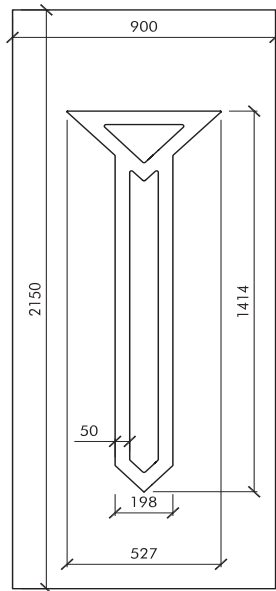

Gava 832

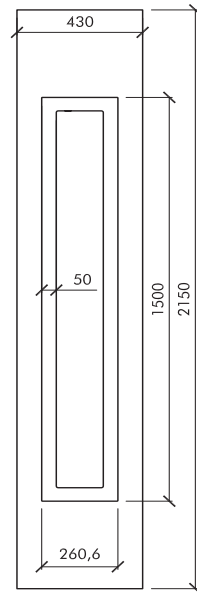

860/2

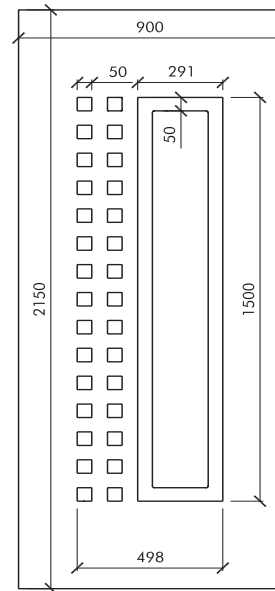

Gava 860

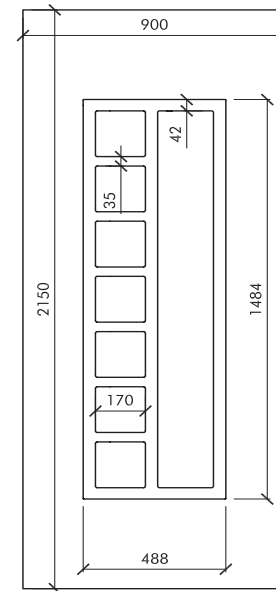

Gava 862

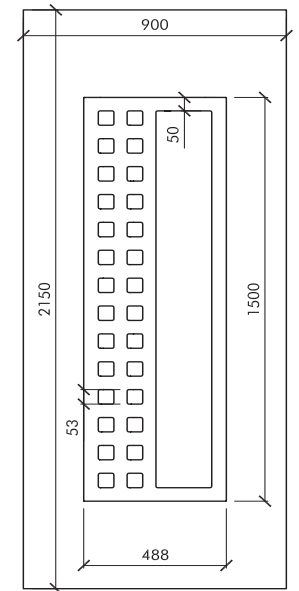

Gava 863

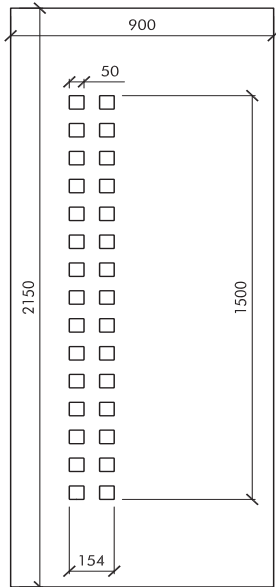

Gava 864

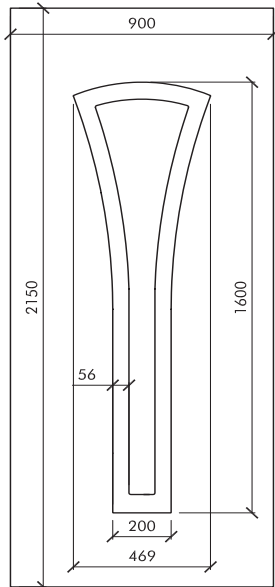

Gava 871

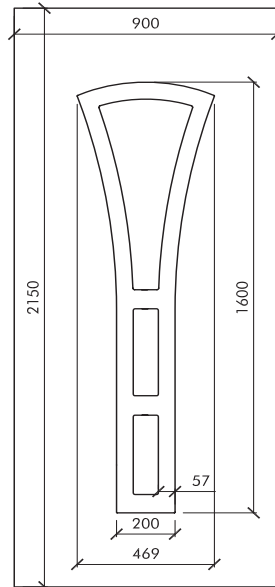

Gava 873

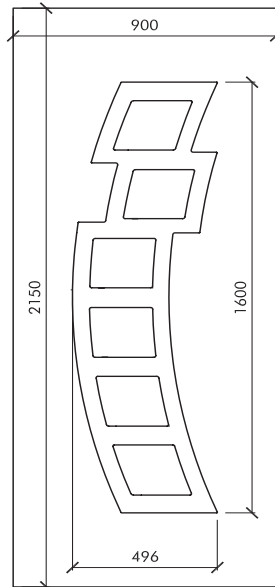

Gava 892

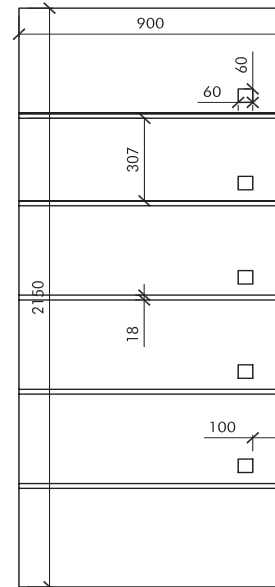

Gava 900

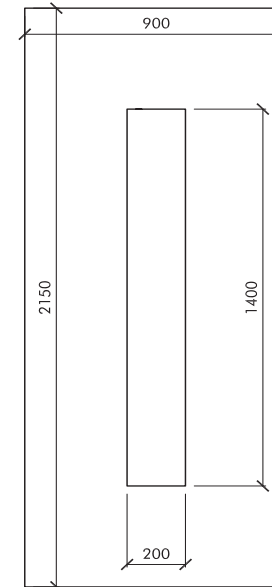

Gava 912

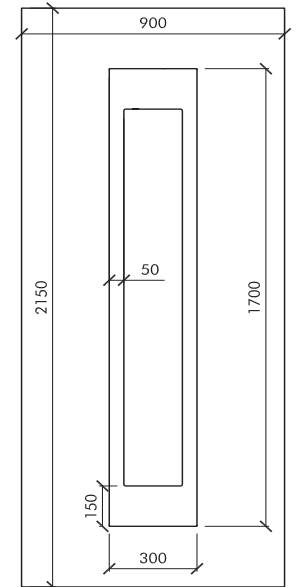

Gava 912a

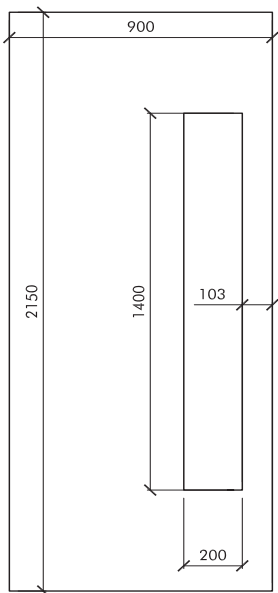

Gava 913

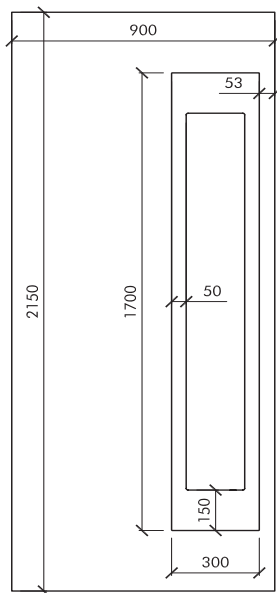

Gava 913a

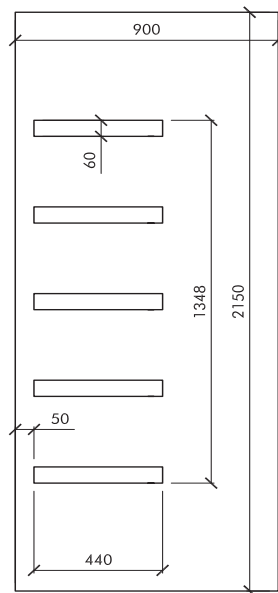

Gava 916

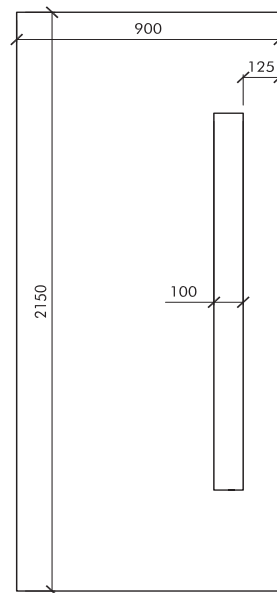

Gava 917

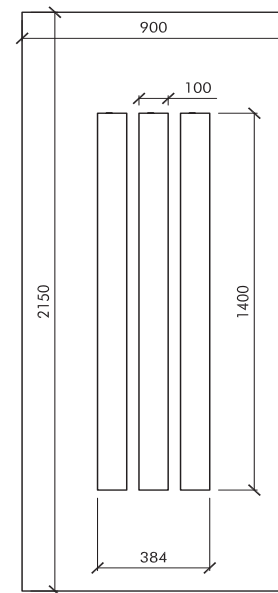

Gava 918

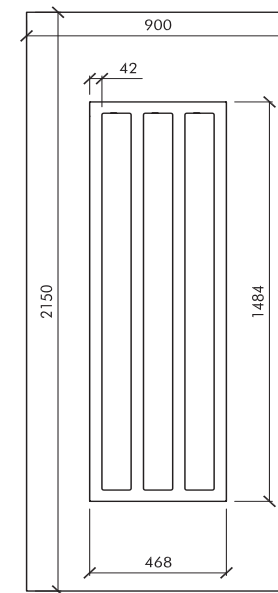

Gava 918a

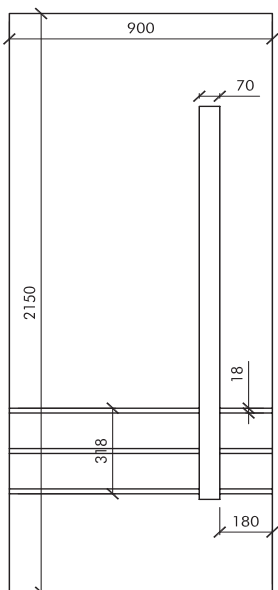

Gava 919

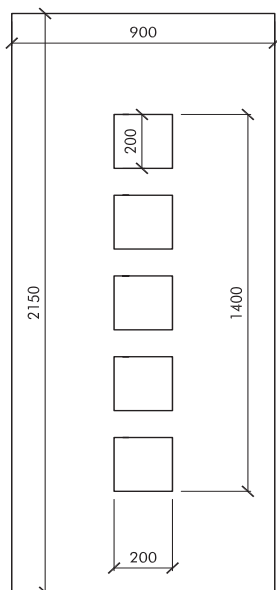

Gava 926

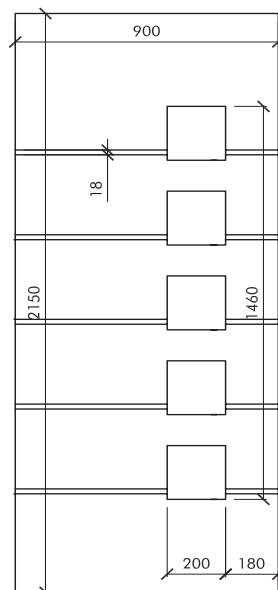

Gava 928

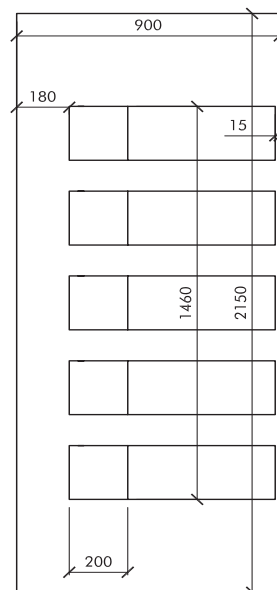

Gava 929a

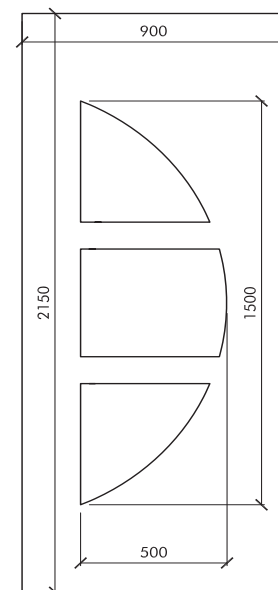

Gava 939

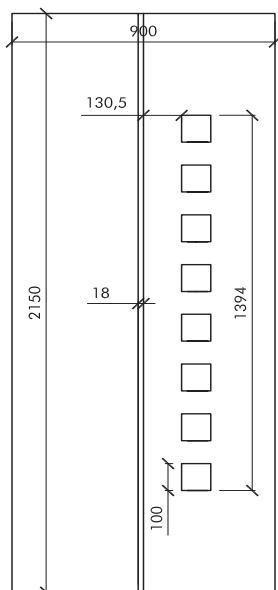

Gava 946

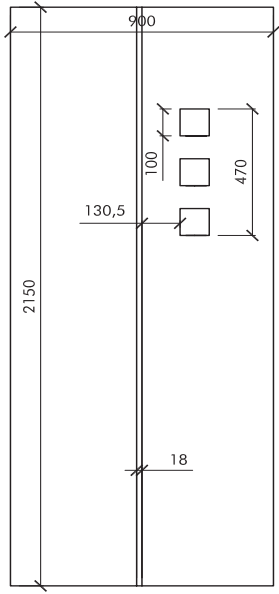

Gava 947

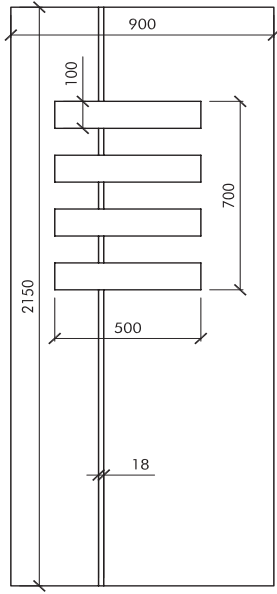

Gava 948

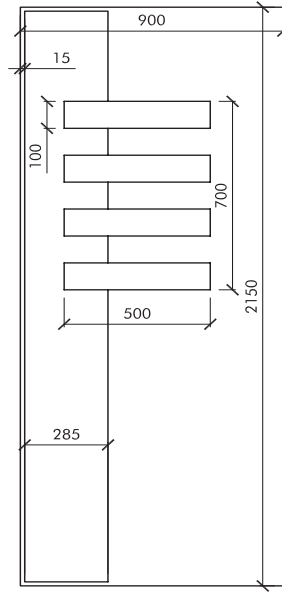

Gava 949

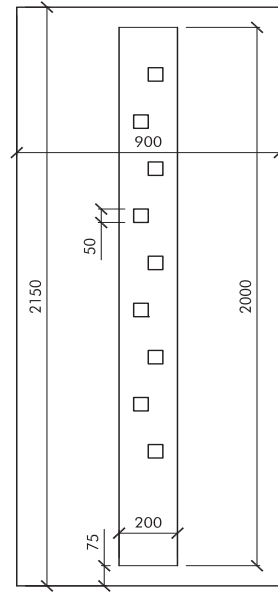

Gava 950

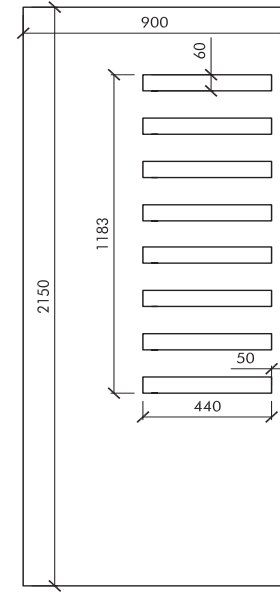

Gava 951

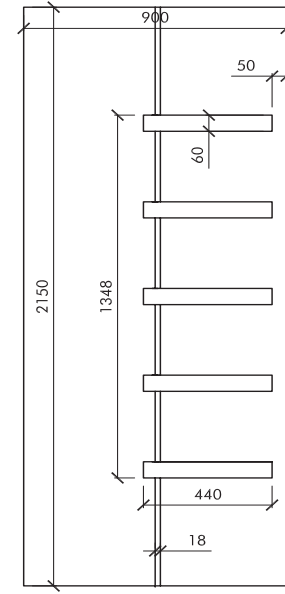

Gava 952

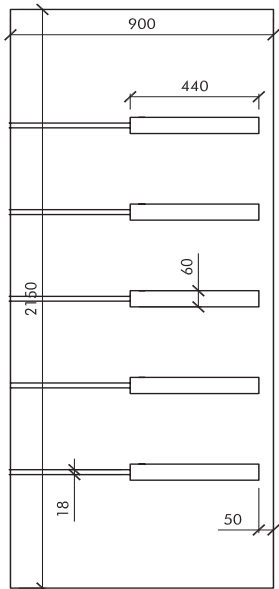

Gava 953

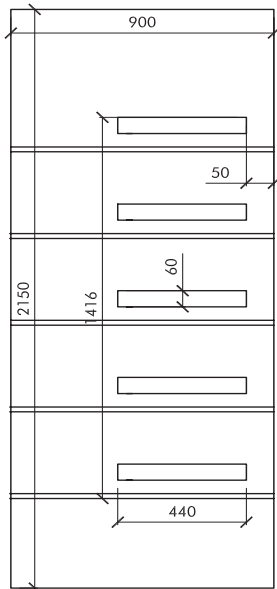

Gava 954

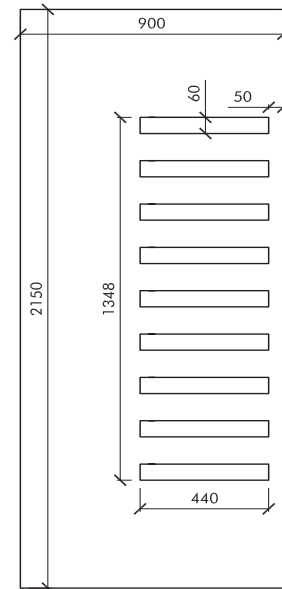

Gava 955

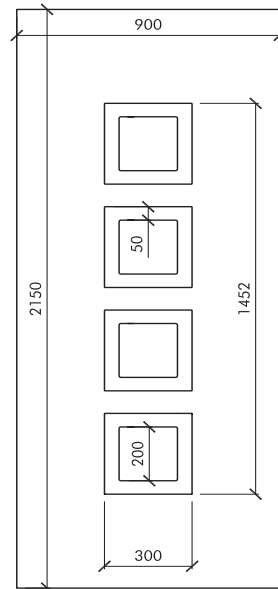

Gava 961a

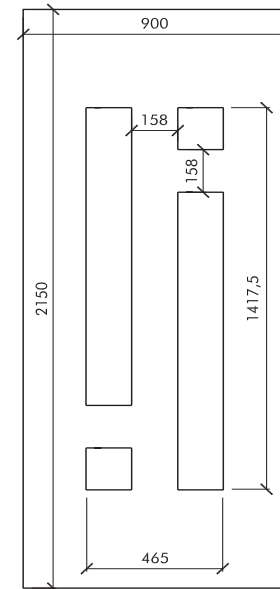

Gava 964

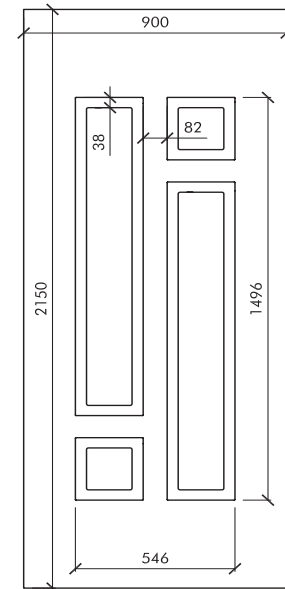

Gava 964q

GAVA plast

GAVA aluminium

CLASSIC

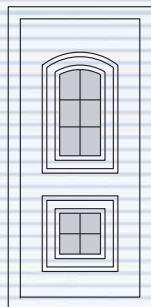

GAVA 010

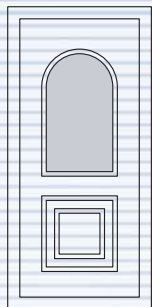

GAVA 020

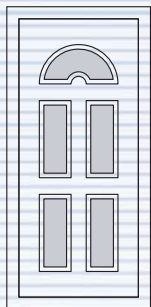

GAVA 030

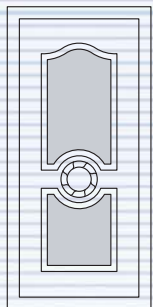

GAVA 040

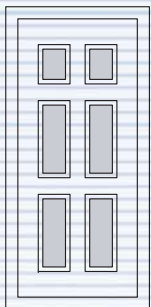

GAVA 060

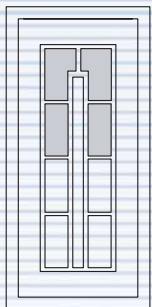

GAVA 280



GAVA 400

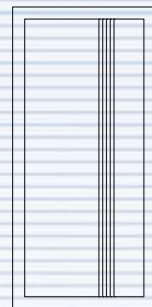

GAVA 401



GAVA 402



GAVA 403

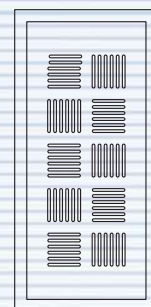

GAVA 404

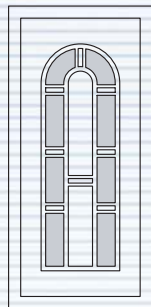

GAVA 070

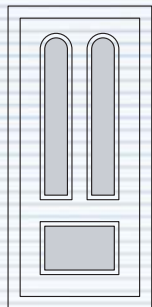

GAVA 080

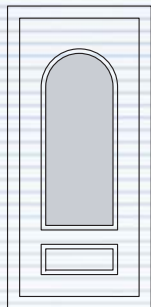

GAVA 240

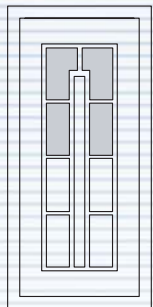

GAVA 280

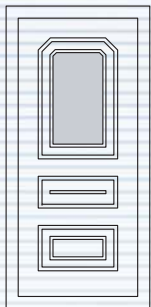

GAVA 250

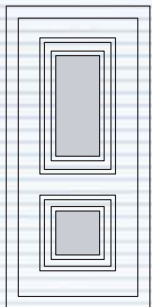

GAVA 220

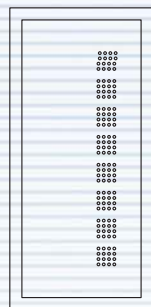

GAVA 405

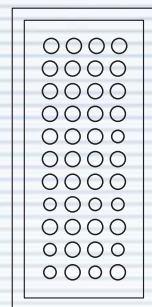

GAVA 406

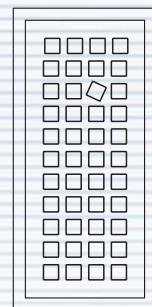

GAVA 407

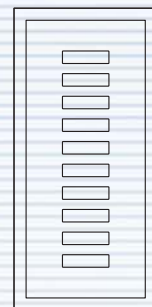

GAVA 408

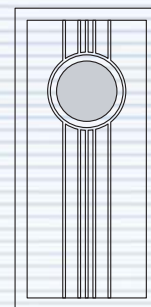

GAVA 409

MODERN

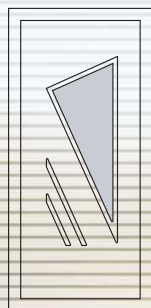

GAVA 090

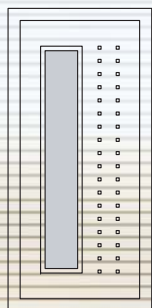

GAVA 260

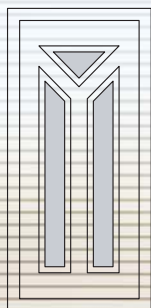

GAVA 050

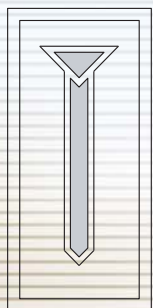

GAVA 230

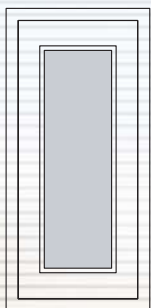

GAVA 100

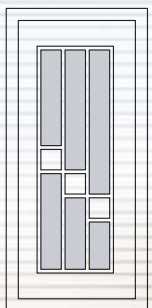

GAVA 130

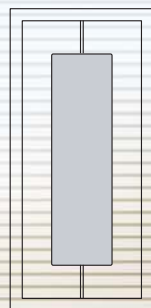

GAVA 410

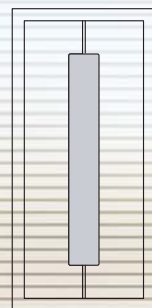

GAVA 411

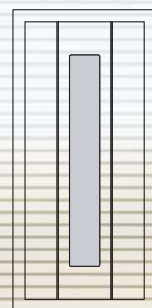

GAVA 412

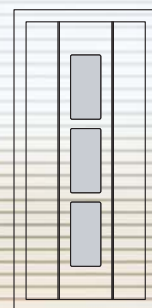

GAVA 413

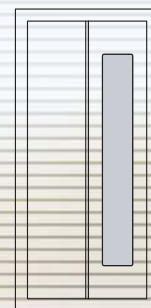

GAVA 414

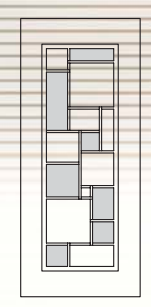

GAVA 140

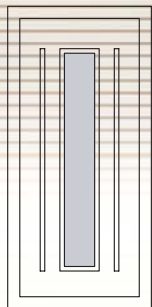

GAVA 150

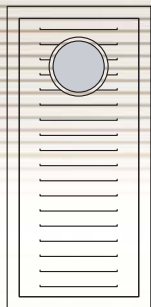

GAVA 200

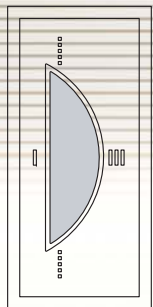

GAVA 210

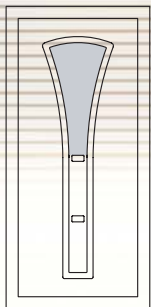

GAVA 270

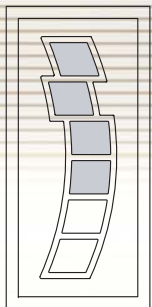

GAVA 290

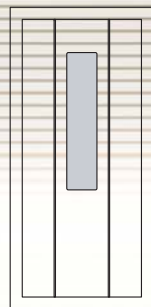

GAVA 415

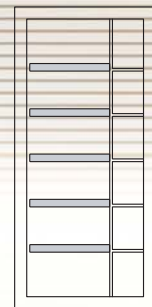

GAVA 416

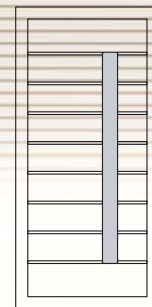

GAVA 417

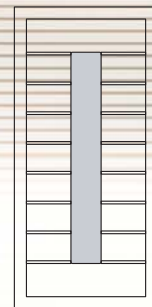

GAVA 418



GAVA 419

GAVA aluminium

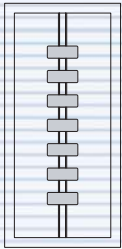

GAVA 420

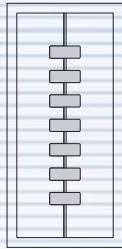

GAVA 421

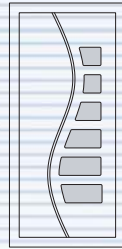

GAVA 430

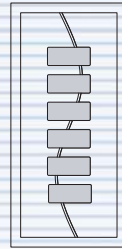

GAVA 431

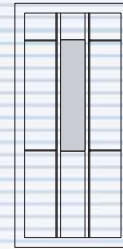

GAVA 440



GAVA 441

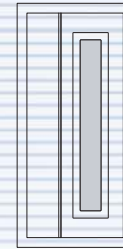

GAVA 450



GAVA 451

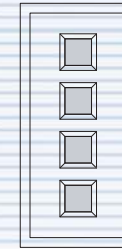

GAVA 460

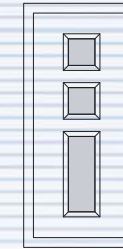

GAVA 461

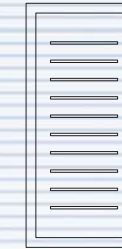

GAVA 470



GAVA 471

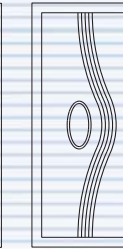

GAVA 480

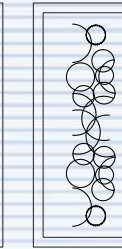

GAVA 481

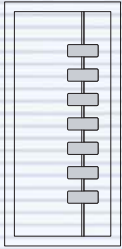

GAVA 422



GAVA 423

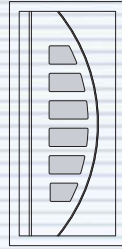

GAVA 432

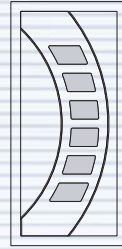

GAVA 433

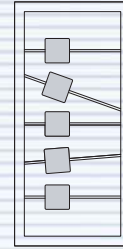

GAVA 442



GAVA 443

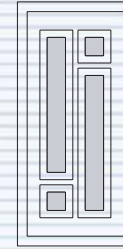

GAVA 452

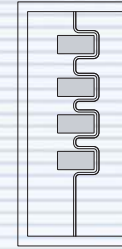

GAVA 453

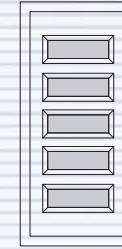

GAVA 462

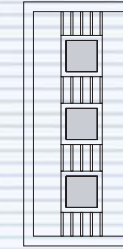

GAVA 463

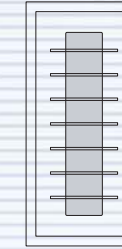

GAVA 472



GAVA 473

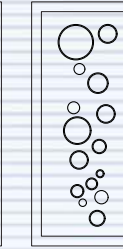

GAVA 482

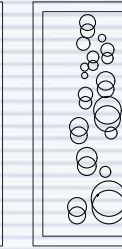

GAVA 483

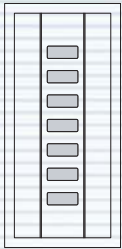

GAVA 424

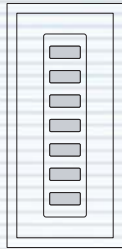

GAVA 425

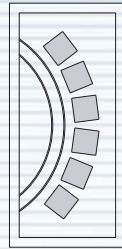

GAVA 434

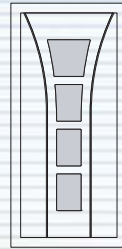

GAVA 435

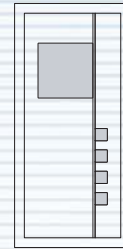

GAVA 444

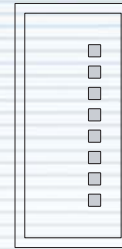

GAVA 445

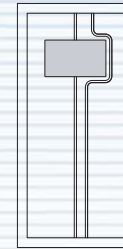

GAVA 454

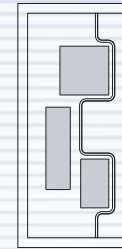

GAVA 455

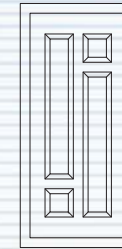

GAVA 464



GAVA 465



GAVA 474

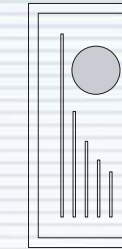

GAVA 475

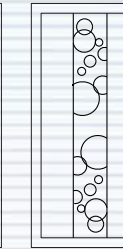

GAVA 484

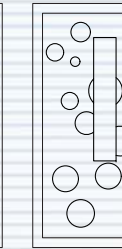

GAVA 485

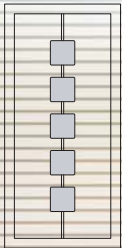

GAVA 426

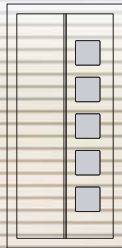

GAVA 427

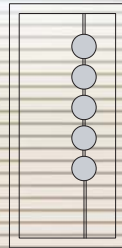

GAVA 436

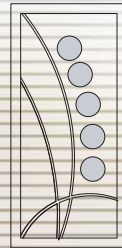

GAVA 437

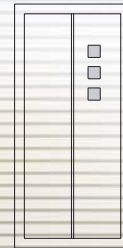

GAVA 446

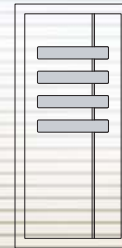

GAVA 447

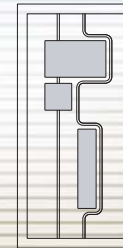

GAVA 456

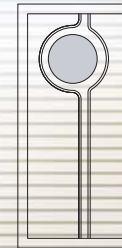

GAVA 457



GAVA 466



GAVA 467

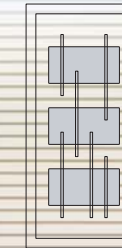

GAVA 476



GAVA 477



GAVA 486



GAVA 487

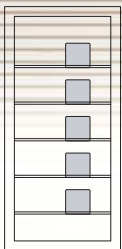

GAVA 428

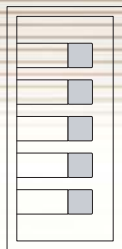

GAVA 429

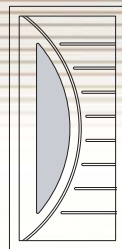

GAVA 438

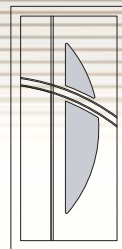

GAVA 439

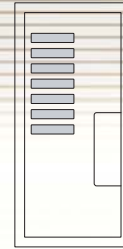

GAVA 448



GAVA 449

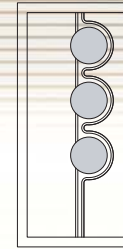

GAVA 458

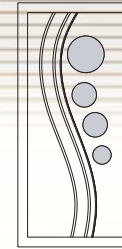

GAVA 459

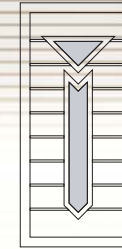

GAVA 468

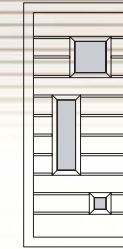

GAVA 469

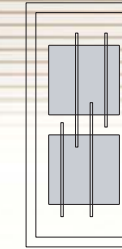

GAVA 478

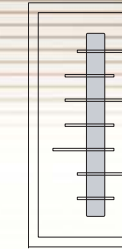

GAVA 479

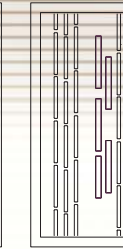

GAVA 488



GAVA 489

GAVA HPL

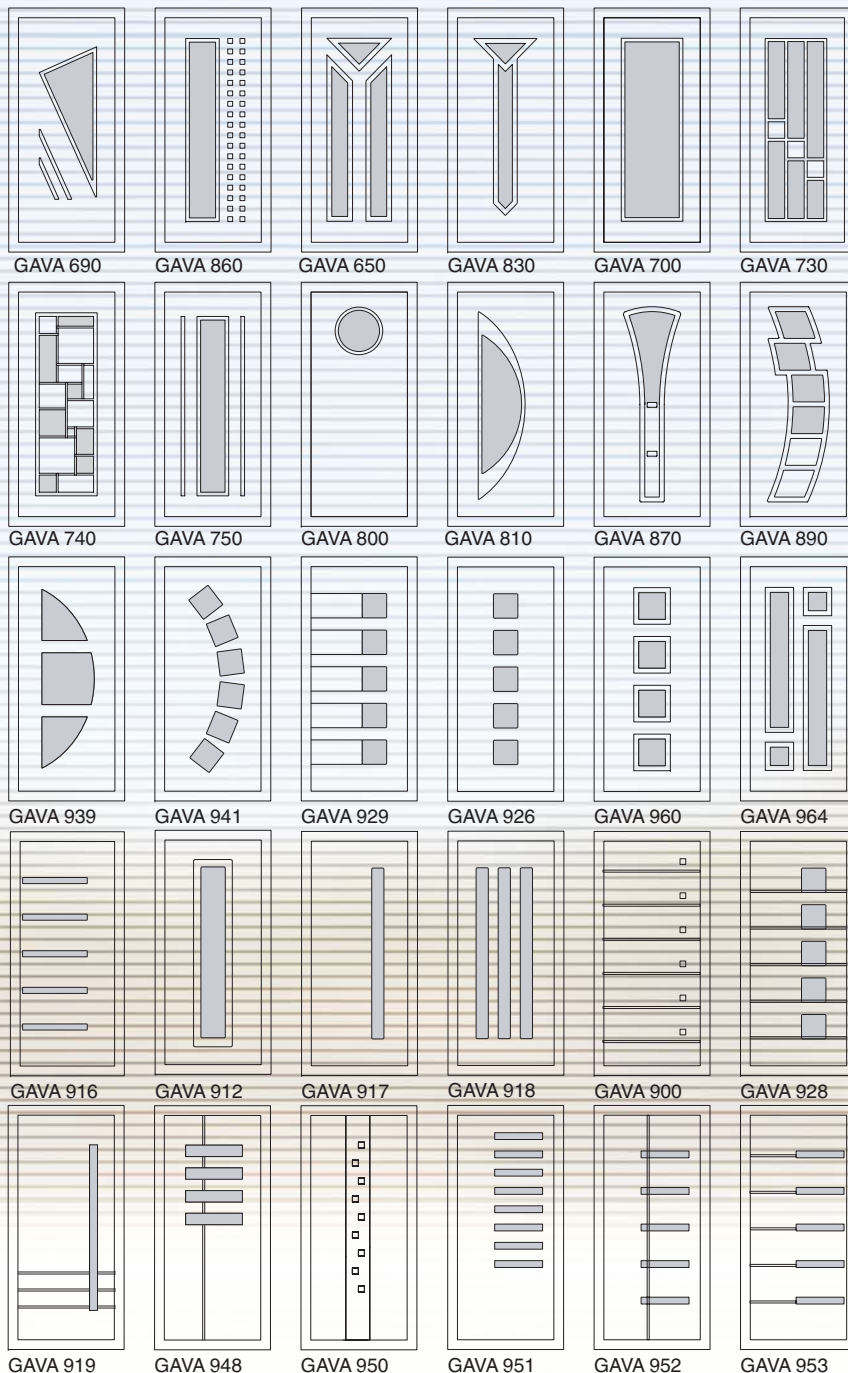

TARTALOMJEGYZÉK

GAVApplast CLASSIC

3-19

GAVA 010 , 020, 030, 040, 060,

GAVA 070, 080, 240, 250, 280

GAVApplast MODERN

20-42

GAVA 050, 090, 260, 230

GAVA 100, 120, 130, 140, 150 - 180

GAVA 200, 210, 220, 270, 290

GAVApplast PVC színválaszték

GAVA aluminium

43-70

GAVA 400 - 470

GAVA 480 - újdonság

GAVAaluminium színválaszték

GAVA HPL

71-92

GAVA 600 - 990

GAVA hpl INTARZIA

GAVA hpl színválaszték

kiegészítők

93-96

kopogtatók, levélbedobók, kitekintők,
homokfúvott és katedrál üvegek

technikai adatok

97-107

panelek méretei



az ötlettől...a részletekig

Finesa Plusz Kft.

✉ 1119 Budapest,

Csurgói út 15.

☎ 06-1-371-1990

📠 06-1-371-1991

@ finesa@finesa.hu

www.finesa.hu

Az Ön forgalmazója:

www.gavaplast.sk